



ISTITUTO NAZIONALE DI RICERCA METROLOGICA Repository Istituzionale

Intercomparison of flow facilities for dynamic flow changes based on WLTC and WHTC

Original

Intercomparison of flow facilities for dynamic flow changes based on WLTC and WHTC / Borchling, Alexander; Kroner, Corinna; Bissig, Hugo; Furuichi, Noriyuki; Malengo, Andrea; Postrioti, Lucio; Romeo, Raffaella; Romieu, Kevin; Warnecke, Heiko; Yoshida, Taiki. - (2024). [10.7795/110.20241125]

Availability:

This version is available at: 11696/84380 since: 2025-02-10T09:10:45Z

Publisher:

Published

DOI:10.7795/110.20241125

Terms of use:

This article is made available under terms and conditions as specified in the corresponding bibliographic description in the repository

Publisher copyright

(Article begins on next page)

Alexander Borchling, Corinna Kroner, Hugo Bissig, Noriyuki Furuichi,
Andrea Malengo, Lucio Postriotti, Raffaella Romeo, Kevin Romieu,
Heiko Warnecke, Taiki Yoshida

Intercomparison of flow facilities for dynamic flow changes based on WLTC and WHTC

ISSN 2751-6598
ISBN 978-3-944659-40-4
DOI 10.7795/110.20241125

Physikalisch-Technische Bundesanstalt

Metrologie

PTB-M-8

Braunschweig, 2. Dezember 2024

Alexander Borchling, Corinna Kroner, Hugo Bissig, Noriyuki Furuichi,
Andrea Malengo, Lucio Postriotti, Raffaella Romeo, Kevin Romieu,
Heiko Warnecke, Taiki Yoshida

Intercomparison of flow facilities for dynamic flow
changes based on WLTC and WHTC

ISSN 2751-6598

ISBN 978-3-944659-40-4

DOI 10.7795/110.20241125

Empfohlene Zitierweise/recommended citation

Borchling A., Kroner C., Bissig H., Furuichi N., Malengo A.,
Postrioti L., Romeo R., Romieu K., Warnecke H., Yoshida T., 2024.

*Intercomparison of flow facilities for dynamic flow
changes based on WLTC and WHTC.*

Braunschweig:

Physikalisch-Technische Bundesanstalt.

PTB-Bericht M-8. ISBN 978-3-944659-40-4.

Verfügbar unter: <https://doi.org/10.7795/110.20241125>

Herausgeber:

Physikalisch-Technische Bundesanstalt

ISNI: 0000 0001 2186 1887

Presse und Öffentlichkeitsarbeit

Bundesallee 100

38116 Braunschweig

Telefon: (05 31) 592-93 21

Telefax: (05 31) 592-92 92

www.ptb.de



The EMPIR initiative is co-funded by the European Union's Horizon 2020 research and innovation programme and the EMPIR Participating States

20IND13 Sustainable advanced flow meter calibration for the transport sector

Intercomparison of flow facilities for dynamic flow changes based on WLTC and WHTC

Pilot
PTB / Germany

This project has received funding from the EMPIR programme co-financed by the Participating States and from the European Union's Horizon 2020 research and innovation programme.

02.12. 2024

Contents

1	Introduction	3
2	Carrying out the test measurements	3
2.1	Participants and planning	3
2.2	Dynamic flow profiles	4
2.3	Validation Module.....	5
2.4	Measurement procedure	6
2.4.1	Static measurements	6
2.4.2	Dynamic measurements	7
2.5	Evaluation procedure	9
2.5.1	Characterisation of the transfer setup	9
2.5.2	Static measurements	11
2.5.3	Dynamic measurements	11
3	Results of the static measurements	12
3.1	Stability of the transfer set.....	12
3.1.1	Drift of the Coriolis flow meter.....	12
3.1.2	Zero drift.....	12
3.1.3	Normalized Degree of Equivalence (E_n – value).....	13
3.2	Laboratory results	13
4	Evaluation of the dynamic measurements	14
4.1	Laboratory results	14
4.1.1	CETIAT	14
4.1.2	NMIJ.....	15
4.1.3	PTB Water	16
4.1.4	PTB oil	17
4.1.5	INRIM.....	18
4.1.6	UNIPG.....	18
4.1.7	METAS.....	19
4.2	Key figures comparison.....	19
5	Summary and conclusion	23
6	ANNEX	24
6.1	Fluid properties	24
6.2	Test bench descriptions	24
6.2.1	CETIAT	24
6.2.2	PTB (water).....	25
6.2.3	PTB (calibration oil)	26

6.2.4	INRIM.....	27
6.2.5	UNIPG.....	28
6.3	Overview of the measurement results	35
6.3.1	Static measurements	35
6.3.2	Dynamic measurement	38
6.4	Distribution of residuals.....	40
7	References	43

1 Introduction

Under operating conditions, flow meters seldom experience the constant flow rates typically encountered during laboratory calibrations. Instead, they are often subjected to variable and irregular flow changes. The central question is how these conditions impact the measurement accuracy of the flow meters and how this accuracy can be substantiated. Simpler approaches to assess this involve applying periodic or cyclic flow changes with varying repetition times. By observing the response to abrupt flow changes, such as an instantaneous transition from a constant flow rate to zero flow (or vice versa), valuable information about the meter's response behaviour can be obtained. Another approach is to expose the flow meter to flow profiles that closely mimic those it will encounter in its intended field application. This necessitates the use of one or more application-specific test profiles.

In order to test measurement devices under these dynamic conditions, it is necessary to establish an infrastructure that allows traceable measurements. It is crucial to recognise that there is no single technology for generating dynamic flow changes. The appropriate technology depends on the specific flow variations to be tested. Consequently, the quality of the realisation of the dynamic flow profile and therefore the measurement uncertainty can vary.

In this report, the technologies used at the institutes to generate test profiles representing fuels demands of the engine control unit of passenger cars and trucks developed in the SAFEST project [1] were compared with each other to find out whether there is a technology that is particularly suitable for realising the defined profiles. A dedicated transfer set was provided for the comparison and the profiles were to be realised with either water or calibration oil according to ISO 4113.

2 Carrying out the test measurements

2.1 Participants and planning

The participants and time schedule are shown in the Table 1. The inter-comparison started in December 2023 at the pilot laboratory PTB and finished in August 2024. Changes had to be made to the original schedule due to delays caused by transportation.

For internal reasons, the planned measurements with calibration oil at METAS could not be carried out.

Table 1: Participants and time schedule

Institute	Country	Shipping address	Contact/mail	Type of liquid	Date
PTB (Pilot)	Germany	Physikalisch-Technische Bundesanstalt Fachbereich 1.5 Flüssigkeiten Bundesallee 100, 38116 Braunschweig	Alexander Borchling alexander.borchling@ptb.de	Water Calibration oil (ISO 4113)	November 2023 August 2024
CETIAT	France	CETIAT Laboratoire Micro-Débitmètrie Liquide Domaine Scientifique de la Doua 54, boulevard Niels Bohr FR - 69100 Villeurbanne - France	Kevin Romieu kevin.romieu@CETIAT.fr	Water	December 2023 January 2024
METAS	Swiss	Eidgenössisches Institut für Metrologie Lindenweg 50 CH-3003 Bern-Wabern	Hugo Bissig Hugo.Bissig@metas.ch	Water Calibration oil (ISO 4113)	April 2024 July 2024
UNIPG	Italy	Università degli studi di Perugia Dipartimento di ingegneria Via durante 67 I – 06125 Perugia Italy	Lucio Postrioti lucio.postrioti@unipg.it	Water Calibration oil (ISO 4113)	February 2024
INRIM	Italy	Istituto Nazionale di Ricerca Metrologica Strada delle Cacce 91, I-10135, Torino Italy	Raffaella Romeo r.romeo@inrim.it	Water Calibration oil (ISO 4113)	March 2024
AIST NMIJ	Japan	Measurement at PTB	Noriyuki Furuichi furuichi.noriyuki@aist.go.jp	Water Calibration oil (ISO 4113)	May 2024

2.2 Dynamic flow profiles

In the scope of the Safest project four test profiles were derived based on the Worldwide harmonised Light vehicles Test Cycle (WLTC) and the World Harmonised Transient Cycle (WHTC) which reflect the fuel demand of an engine control unit (Figure 1; [2][3]). The task was to set up test benches in such a way that they are able to generate and measure these profiles. The aim of the inter-comparison was to evaluate these realizations.

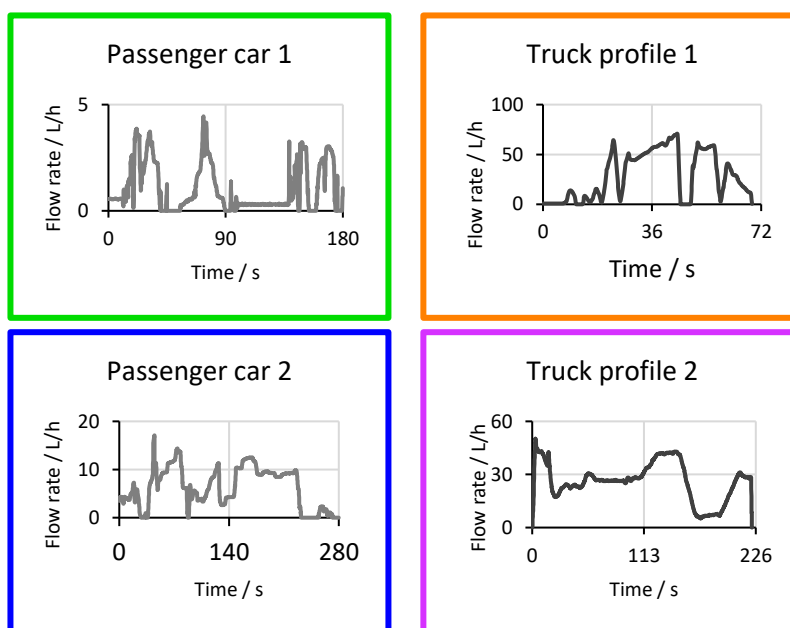

Figure 1: Test profiles used to compare the test benches

2.3 Validation Module

For the inter-comparison a dedicated transfer setup was built. The transfer set consists of a case including the following elements:

1. Endress+Hauser Cubemass 300 DN02 Coriolis flow meter with transmitter
2. 2 Bürkert Typ 8325 pressure sensors
3. 2 TMH Pt100 temperature sensors.

A laptop with power supply and connection to the case is also provided. Figure 2 shows the arrangement of the Coriolis flow meter and sensors in the case. LAN connection and the main power plug must be connected to the transfer setup. The case also includes a box for the electronic connections, shown in Figure 3:

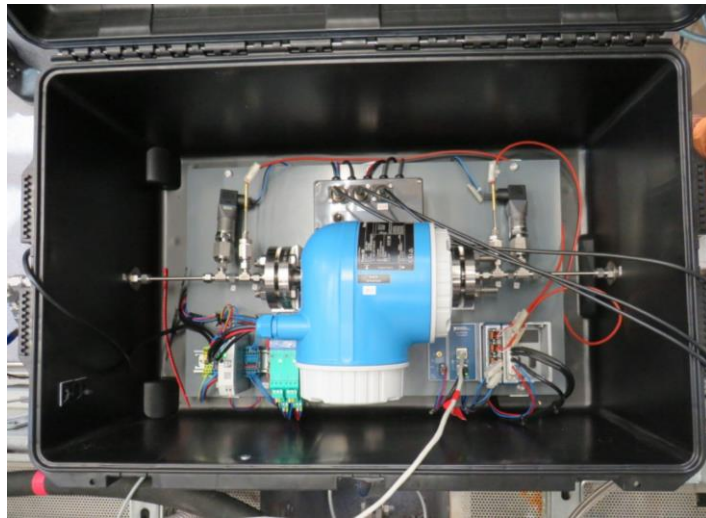

Figure 2: Transfer set.

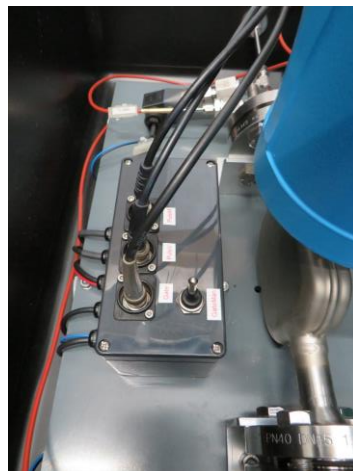

Figure 3: Electronic box in the transfer setup.

There are three BNC connectors on the electronic box:

1. Gate Signal "Gate"
2. Volume Pulse Output
3. Mass Pulse Output.

The mass pulse output of the Coriolis flow meter which was used in the inter-comparison is set to the predefined resolution of 360 000 pulses/kg. This value was to be used for the calibration. In addition, there is a small lever on the box with which the gate signal for recording can be switched manually (“GateMan”). Depending on the position of the switch, the gate signal of the test bench can be used.

2.4 Measurement procedure

The measurement procedure for each test liquid is divided into two parts, one static measurement regime and one dynamic regime. In the static regime, the flow rates are set constant, and the results of the transfer set are compared with the reference.

In case of the dynamic measurements, the flow profiles of section 2.2 are realized and the data from the transfer set are compared to the reference. In addition, the data of the transfer set are analysed with respect to the profile realizations.

Apart from NMIJ, all participating laboratories used their own calibration procedures to calibrate the transfer standard. NMIJ sent their system for generating dynamic flow profiles to PTB to carry out the dynamic measurements on the test bench there. Table 2 provides an overview of the participating laboratories, the type of facility, the calibration method, the measurement range and further literature references. For the measurements at PTB with water and calibration oil two different test benches were used.

Table 2: Participants and additional information about used test benches and technologies.

Institute	Country	Test bench/reference	Measured flow range in L/h	Test liquid	Flow change technology	References
CETIAT	France	Gravimetric with weighing system	0.25 - 100	Water	Valves	6.2.1
METAS	Swiss	Reference flow meter	?	Water	Prover	
NMIJ	Japan	Gravimetric with weighing system (PTB)	0.25 - 100	Water	Prover	[5]
PTB	Germany	Gravimetric with weighing system	0.25 - 100	Water	Herschel-Venturi nozzles	6.2.2
PTB	Germany	Gravimetric with weighing system	0.25 - 100	Calibration oil ISO 4113	Herschel-Venturi nozzles	6.2.3
INRIM	Italy	Gravimetric with weighing system	0.25 - 30	Calibration oil ISO 4113	Injector nozzles	6.2.4
UNIPG	Italy	Reference flow meter	0.25 - 20	Calibration oil ISO 4113	Injector nozzles	6.2.5

2.4.1 Static measurements

The participating laboratories had to ensure that the ambient conditions during the measurements should be:

- Ambient temperature: 20 °C ± 5 °C,
- Ambient humidity: from 45 % to 65 %,
- Atmospheric pressure: from 86 kPa to 106 kPa.

Before starting the measurements, the device under test (DUT) was to be stored in the laboratory for at least 8 hours to acclimatize.

Then a static calibration in accordance with the internal calibration procedure at each laboratory was to be performed, following the requirements:

- Install, purge and warm-up the transfer set using your internal procedures, in particular pay attention to degassing the test bench. The case should be set up horizontally.
- Perform "auto zero" of the transfer set:
 - Open the Link at the desktop (Promass300)
 - Enter PIN: 0000
 - Go to MainMenu -> Expert -> Sensor -> Sensor Adjustment
 - Make sure that no flow exists and a stable pressure of 3 bar is set
 - Chose flow in arrow direction
 - Start "zero-point adjustment"
 - Go to the calibration values to check the new zero-point of the Coriolis flow meter
 - Note the zero-value displayed after zero calibration. The easiest way would be to save a screenshot of the zero-value at the computer.
- Perform a measurement (recordings on the laptop and the data acquisition system of the test bench) of 10 minutes at zero flow to check the zero-value stability and note the number of pulses.
- Repeat the zero measurement three times.
- Connect the pulse output to the test bench's data acquisition system.
- Record all data during the calibration measurements using the laptop. At the same time, record the data of the Coriolis flow meter and all relevant parameters (i.e. inline pressure and temperature) using the test bench's sensors and acquisition system.
- Perform a static calibration with constant flow rates at room temperature at the following flow points, each measurement point has to be repeated 5 times and then move t to the next point:
 - 0.25 L/h
 - 0.5 L/h
 - 1 L/h
 - 5 L/h
 - 10 L/h
 - 20 L/h
 - 60 L/h
 - 100 L/h
- Upload the laptop recordings to the "PTBbox" with the URL: "https://box.ptb.de/getlink/fiRQ8r1zBN4W67SUgkfPtXhK/Intercomparison" for each individual measurement (8 flow rates repeated 5 times = 40 measurements) before sending the transfer set to the next laboratory
- Additionally, provide the following calibration data from the test bench (Table 3) to the pilot laboratory for each individual measurement and repetition also before sending the transfer set to the next laboratory.

Table 3: Data to be provided for the static calibration from the test bench.

nominal flow rate	Measurement id	average upstream pressure	average water temperature	average reference mass flow rate	indicated mass flow rate by transfer setup	relative error	relative expanded uncertainty ($k=2$)
(L/h)	(-)	(bar)	(°C)	(kg/h)	(kg/h)	(%)	(%)

2.4.2 Dynamic measurements

2.4.2.1 Protocol

The ambient conditions during the dynamic measurements should be analogue to those of the static measurements:

- Ambient temperature: 20 °C ± 5 °C,
- Ambient humidity: from 45 % to 65 %,
- Atmospheric pressure: from 86 kPa to 106 kPa.
- The dynamic calibration should be performed in accordance with the internal test bench calibration procedure. If possible, all four profiles should be realized on the test bench. Each profile was to be repeated 5 times. The measurement procedure was to install, vent and warm up the transfer set using your internal procedures, paying particular attention to the degassing of the test bench. The housing should be set up horizontally.
- Perform "auto zero" of the transfer set (see static calibration) (see static calibration). Note the zero-value displayed after zero calibration.
- Perform a measurement (recordings on the laptop and the data acquisition system of the test bench) of 10 minutes at zero flow (three times) to check the zero-value stability.
- Connect the pulse output to your test bench's data acquisition system.
- Record all data during the calibration measurements using the laptop, following the protocol. At the same time, record the data from the Coriolis flow meter and all relevant parameters (i.e. water pressure and temperature) using your test bench's sensors and acquisition system.
- Realize the dynamic profiles and perform a dynamic calibration at room temperature.
- Upload the laptop recordings to the "PTB-box" with the URL: "https://box.ptb.de/getlink/fiRQ8r1zBN4W67SUgkfPtxhK/Intercomparison" for each individual measurement (4 profiles repeated 5 times = 20 measurements).
- Additionally, provide the following calibration data from the test bench to the pilot laboratory for each individual profile measurement:

Table 4: Data to be provided from the test bench.

profile n°	repetition	average upstream pressure (bar)	average water temperature (°C)	average DUT mass flow rate	average reference mass flow rate	average reference totalized mass	relative expanded uncertainty ($k=2$)
------------	------------	---------------------------------	--------------------------------	----------------------------	----------------------------------	----------------------------------	---

For each measurement, the mean values of the ambient conditions were to be provided for the protocol.

Furthermore, details of the test liquid(s) were asked for:

- Information about the type of liquid
- Current temperature dependent information on the density and viscosity of the test liquid.

The following measured parameters were to be reported according to Table 3 and Table 4:

- Average upstream pressure and temperature at the device under test
- Average mass flow rate by the meter
- Average totalized mass detected by the meter
- Average reference mass flow rate
- Average reference totalized mass
- The relative error of the transfer set
- Uncertainty of the reference flow ($k=2$).

In addition to the data recorded on the laptop and the averaged data from the test bench, the following parameters were to be recorded on the test bench during the measurements:

- High resolution temporal monitoring and recording of flow rates, fluid temperature, fluid pressure (recommendation: sampling rate of at least 20 Hz)

- Highly resolved temporal monitoring and recording of reference measurements.

For the uncertainty of the reference the CMC of the facility should be used. Furthermore, it was requested to send the results to the pilot laboratory before sending the transfer setup to the next partner, latest within 1 month after the tests had been performed. Moreover, the participants were asked to use the table in Excel sheet format to report the individual measurement results.

2.5 Evaluation procedure

2.5.1 Characterisation of the transfer setup

2.5.1.1 Stability of the transfer setup

The stability of the transfer standard was validated at the pilot laboratory (PTB) by static calibrations (constant flow rates) at 0.25 L/h, 0.5 L/h, 1 L/h, 5 L/h, 10 L/h, 20 L/h, 60 L/h and 100 L/h for the transfer set. The measurements were carried out with calibration oil and water. The nominal k -factor of 360 000 pulses per Liter was used to calculate the error.

The drift is calculated from the difference between the measurement deviation at the start measurement minus the measurement deviation at the end measurement.

The uncertainty associated with the drift of the transfer standard, assuming a rectangular distribution of the drift, is:

$$u_{drift} = \frac{drift}{2\sqrt{3}}.$$

2.5.1.2 Zero drift

The zero drift was analysed by measuring the mass flow rate three times with the upstream and downstream valves closed for 10 minutes during each flow calibration in the participating laboratories.

The uncertainty $u_{zero\ drift}$ is calculated from:

$$u_{zero\ drift} = \frac{average\ zero\ drift}{target\ flow\ rate * \sqrt{3}}.$$

2.5.1.3 Normalized Degree of Equivalence (E_N – value)

The key comparison reference value (KCRV) and its associated uncertainty were determined for each individual flow rate by employing the weighted average of the uncertainties reported by the participating laboratories. All results were then compared against this reference value. Finally, the chi-squared test was used to perform a consistency check of the laboratory results.

In order to ascertain the consistency of the results, the well-known Degree of Equivalence $E_{n_{lab\ i}}$ was employed. This value is defined as follows:

$$E_{n_{lab\ i}} = \frac{\varepsilon_{lab\ i} - \varepsilon_{RV}}{\sqrt{U^2(\varepsilon_{lab\ i}) - U^2(\varepsilon_{RV})}}$$

where $\varepsilon_{lab\ i}$ is the error of laboratory i for a certain flow rate, ε_{RV} is the KCRV for the error and $U(\varepsilon_{lab\ i})$ and $U(\varepsilon_{RV})$ are the expanded uncertainties ($k=2$) of those values. The expanded uncertainty incorporates the uncertainty in the reference flow rate and repeatability. Repeatability is defined as the standard deviation of the individual errors for a given flow profile.

To take into account the drift of the transfer standard, the uncertainty $U(\varepsilon_{lab\ i})$ has been calculated as follows:

$$U(\varepsilon_{lab\ i}) = 2 * \sqrt{\left(\frac{U_{lab\ i}}{2}\right)^2 + u_{drift}^2 + u_{zero\ drift}^2}.$$

$u_{zero\ drift}$ is calculated as described in section 2.5.1.2. The flow-dependent uncertainties of the test bench are used.

The value of E_n has the following meaning:

- The results of a laboratory for a certain flow point are consistent (passed) if $E_n \leq 1$.
- The results of a laboratory for a certain flow point are inconsistent (failed) if $E_n > 1.2$.
- For results between $1 < E_n \leq 1.2$ a “warning level” is defined. For this particular situation the particular laboratory is recommended to check the procedures and methodology.

The comparison reference value is the uncertainty weighted average of the error and is determined as follows:

$$\varepsilon_{RV} = \frac{\sum_{i=1}^n \frac{\varepsilon_{lab\ i}}{U^2(\varepsilon_{lab\ i})}}{\sum_{i=1}^n \frac{1}{U^2(\varepsilon_{lab\ i})}},$$

where n is the number of participating laboratories. The uncertainty of the KCRV follows from:

$$u(\varepsilon_{RV}) = \frac{1}{\sqrt{\sum_{i=1}^n \frac{1}{U^2(\varepsilon_{lab\ i})}}}.$$

The chi-squared test is employed to ascertain whether the identified errors and their associated uncertainties can be anticipated based on a Gaussian distribution. If so, the KCRV can be accepted. The chi-squared test is defined as follows:

$$\chi_{obs}^2 = \sum_{i=1}^n \left(\frac{\varepsilon_{lab\ i} - \varepsilon_{RV}}{u(\varepsilon_{lab\ i})} \right)^2.$$

Note, here $u(\varepsilon_{lab\ i})$ is the standard uncertainty ($k=1$). The set of measurement results for a certain flow point is only accepted when:

$$Pr(\chi^2(v) > \chi_{obs}^2) < 0.05,$$

where Pr stands for probability and $\chi(v)$ is the expected value for a Gaussian distribution. Using the CHIINV(probability, degrees of freedom: $v = n-1$) function from Excel, this can be rewritten as follows for a consistent set (coverage factor 95 %):

$$\chi_{obs}^2 < CHIINV(0.05; n - 1).$$

Hence, if the observed chi-squared value satisfies the above equation, the KCRV is accepted. If not, the result with the largest contribution to χ_{obs}^2 is discarded and the test is repeated (degrees of freedom reduced by one).

2.5.2 Static measurements

The institutes had to provide their data in accordance with the protocol (2.4.1). The flow-dependent k -factor can be used in the subsequent evaluation. In addition, the measurement deviation ε can be calculated using the nominal k -factor of 360 000 pulses per kg.

$$\varepsilon = \frac{\text{pulses counted} - 360\,000}{360\,000} * 100.$$

2.5.3 Dynamic measurements

The mass data of the transfer set is not synchronized. For this reason, the time of the first significant flow change was synchronised for the profiles in a first step. This allows all profiles to be compared on a common time scale.

The recorded time-dependent mass flow data was then compared with the variations of the given flow profiles of Figure 1. This comparison gives a first impression of the quality with which the profiles were realized on the different test benches and provides insights into the characteristics of the different technologies used for profile generation. The flow meter should not be examined here for its dynamic behaviour.

Three key parameters were used in the assessment: the repeatability, the mean of the residuals and the deviation of mass.

2.5.3.1 Repeatability

For further evaluations, the repetitions of a profile were summarized by the arithmetic mean of the mass flow rate to obtain an average profile. The standard deviation was calculated for each measurement point and then the mean value was calculated.

2.5.3.2 Mean of residuals

For each profile repetition the residuals were calculated as the difference between each measured profile and the nominal flow rate of the given profile. In the next step, the average of all residuals of a profile type was calculated. Another aspect of the analysis of the residuals was the histogram of the residuals. For this purpose, histograms with a class division of 0.2 L/h were plotted above the class mean value. It is inevitable that a discrepancy between the expected and actual results will occur when the flow rate is altered, due to the inherent variability in the current flow rate caused by the delay times in the electronics and the reaction time of the system. However, these reaction and delay times are not within the scope of the investigation.

2.5.3.3 Deviation of mass

The relative error of the mass measured by the transfer set was another quantity used to compare the technologies. It is defined as the difference between the mass indicated by the transfer standard and the total mass according to the default profile:

$$\varepsilon_D = \frac{(M_{TS} - M_{def})}{M_{def}},$$

where ε_D is the relative error of the profile realization, M_{TS} is the total mass indicated by the transfer set and M_{def} is the total mass of the default profile.

Based on the reported results the following values were computed: the reference mass in kg, the total mass indicated by the transfer set, the relative error ε_V .

The mass calculated from the pulses was used deliberately, as not all institutes used a gravimetric reference. It is assumed that the deviation caused by the flow meter is comparable at all test benches.

2.5.3.4 Measurement deviation of the Coriolis flow meter

The measurement deviation of the measuring device under dynamic load is calculated as additional information. All institutes use the static k -factor as the basis for this. The measurement deviation is calculated by:

$$\varepsilon_V = \frac{(M_{TS} - M_{ref})}{M_{ref}},$$

where ε_V is the relative error of the transfer set, M_{TS} is the total mass indicated by the transfer set and M_{ref} is the total mass of the reference.

3 Results of the static measurements

3.1 Stability of the transfer set

3.1.1 Drift of the Coriolis flow meter

The measurements show that there is a high dependency of the zero-point setting and the measurement deviation.

The drift is calculated from the difference between the measurement deviation at the start measurement minus the measurement deviation at the end measurement. The flow rate-dependent drift is shown in Table 5.

The zero-point setting has a major influence on flow rates below ~ 10 L/h. This indicates that for flow rates below 10 L/h, the deviation in measurements is not a result of the measuring device's drift, but rather the setting of the zero point.

Table 5: Drift of the transfer set evaluated at the pilot laboratory with calibration oil ISO 4113.

Flow rate	Initial error (08.12.2023)	Final error (09.05.2024)	Flow rate-dependent drift	Uncertainty drift (u_{drift})
L/h	%	%	%	%
0.25	-0.914	0.59	-1.504	-0.434
0.5	-0.618	0.05	-0.668	-0.193
1	-0.218	0.03	-0.248	-0.072
5	-0.059	0.005	-0.064	-0.018
10	-0.005	0.002	-0.007	-0.002
20	0.024	0.01	0.014	0.004
60	0.088	0.0007	0.087	0.025
100	0.121	0.003	0.118	0.034

Table 6: Drift of the transfer set evaluated at the pilot laboratory with water.

Flow rate	Initial error (15.12.2023)	Final error (30.08.2024)	Flow rate-dependent drift	Uncertainty drift (u_{drift})
L/h	%	%	%	%
1	0.529	0.1026	0.4264	0.1231
5	0.0895	-0.0054	0.0949	0.0274
10	0.0569	0.0003	0.0566	0.0163
20	0.0462	0.0081	0.0381	0.011
60	0.0535	0.0275	0.026	0.0075
100	0.0382	0.0379	0.0003	0.0001

3.1.2 Zero drift

The result of the zero drift determination of each laboratory is shown in Table 7. Even if the zero-point was set before each measurement, the meter detects some pulses that are caused by the meter itself

due to its measuring principle and not by a flow rate. The number of incorrectly detected pulses is comparable with each other and is in the range of 0.58 pulses per second and 0.72 pulses per second. The average across all institutions is 0.63 pulses per second. In case of the Coriolis flow meter used $u_{zero\ drift}$ is 0.63 pulses per second. By employing these values, it is feasible to ascertain the extent of the uncertainty associated with the zero point, in relation to the flow rate.

Table 7: Zero drift

Laboratory	Measurement 1	Measurement 2	Measurement 3	Average value
	pulses per second	pulses per second	pulses per second	pulses per second
CETIAT	0.58	0.59	0.58	0.58
PTB water	0.71	0.69	0.72	0.70
PTB oil	0.60	0.60	0.58	0.59
INRIM	-	-	-	0.65
UNIPG	0.62	0.62	0.60	0.61

3.1.3 Normalized Degree of Equivalence (E_n – value)

The E_n -value was subjected to analysis as part of the analysis. During the investigation, it was discovered that, contrary to the original planning, not all laboratories had carried out all the specified measuring points and measurements with both water and calibration oil. This resulted in an insufficient quantity of data. Furthermore, it became evident that the measuring device exhibited a considerable degree of scatter in the measurement deviations due to zero-point effects, particularly in the measuring range of less than 5 L/h. As a result, it was not feasible to analyse the E_n -value in detail.

3.2 Laboratory results

In Figure 4 the results of the static measurements are shown. No dependence on the medium can be recognised from the measurement deviation. The characteristics of the calibration oil employed by the various laboratories are detailed in the appendix. The static measurements from PTB and INRIM show a very good agreement. In the flow rate range below ~10 L/h, clear zero-point effects can be recognised. This shows that the automatic zero-point setting of the Coriolis flow meter should be improved. It should be investigated whether the calculation of an optimum zero-point, as described in [4], would lead to lower measurement deviations at the lower flow rate range. Details on the measurements and measurement conditions are summarized in Annex 6.8. The pressure used for the static measurements differs depending on the institute. However, no specifications were made in this regard. It is to be expected that the Coriolis flow meter works independently of the inline pressure. The temperatures are within the specified range (room temperature) at all institutes.

METAS did not provide the total quantity of pulses, but they calculated a measurement deviation. In addition, it was not possible to measure flow rates of more than 10 L/h with their system.

The static measurements of UNIPG show the expected effects of the zero-point setting on the measurement deviation in the lower flow rate range. However, at flow rates above 10 L/h, effects of the zero-point setting can no longer be the cause for the measurement deviation. Rather, it is due to the reference used. UNIPG was the only institute that did not use a gravimetric reference. A Coriolis flow meter calibrated at INRIM was used as a reference.

It can be assumed that the measurement deviations are due to the reference and not to the transfer set.

CETIAT did not provide any data of the static measurements.

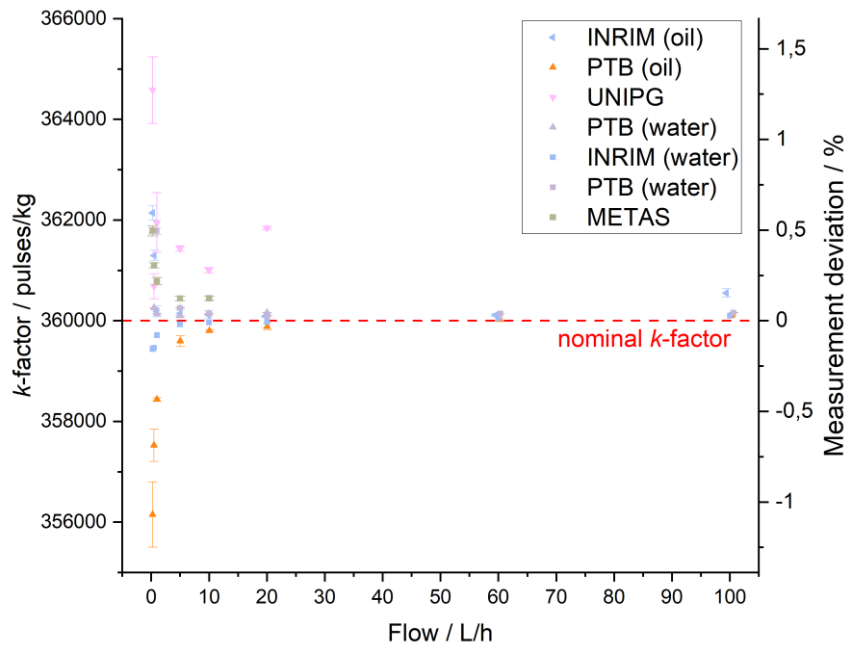

Figure 4: Results of the static measurements (■ water, ▲ calibration oil).

4 Evaluation of the dynamic measurements

4.1 Laboratory results

4.1.1 CETIAT

No reference values are available for the measurements on the CETIAT test bench. This is partly due to the measurement procedure. The respective profile was not realised in five individual measurements, but the five repetitions of the profile were carried out within one measurement. It was therefore not possible to determine the deviation of the mass for a single profile measurement. However, the total mass after 5 repetitions is also missing. It was possible to synchronise the measured profiles so that at least the parameters “mean of residuals” and “repeatability” could be investigated.

In Figure 5 the realization of the four profiles is shown.

The measurements of the two passenger car profiles indicate the presence of undesired fluctuations in the flow rate. This phenomenon can be observed, for instance, at the outset of the passenger car profile 1. Here, there are only minimal flow rate changes, but oscillations occur during the realisation. These are also recognisable in the passenger car profile 2. It is also noticeable in the realisation of the passenger car profiles that the flow points are not hit exactly and that there are flow peaks, especially in the profile 1.

No oscillations can be recognised in the two truck profiles. When realising the truck profiles, however, it is noticeable that the specified flow rates are not generated exactly.

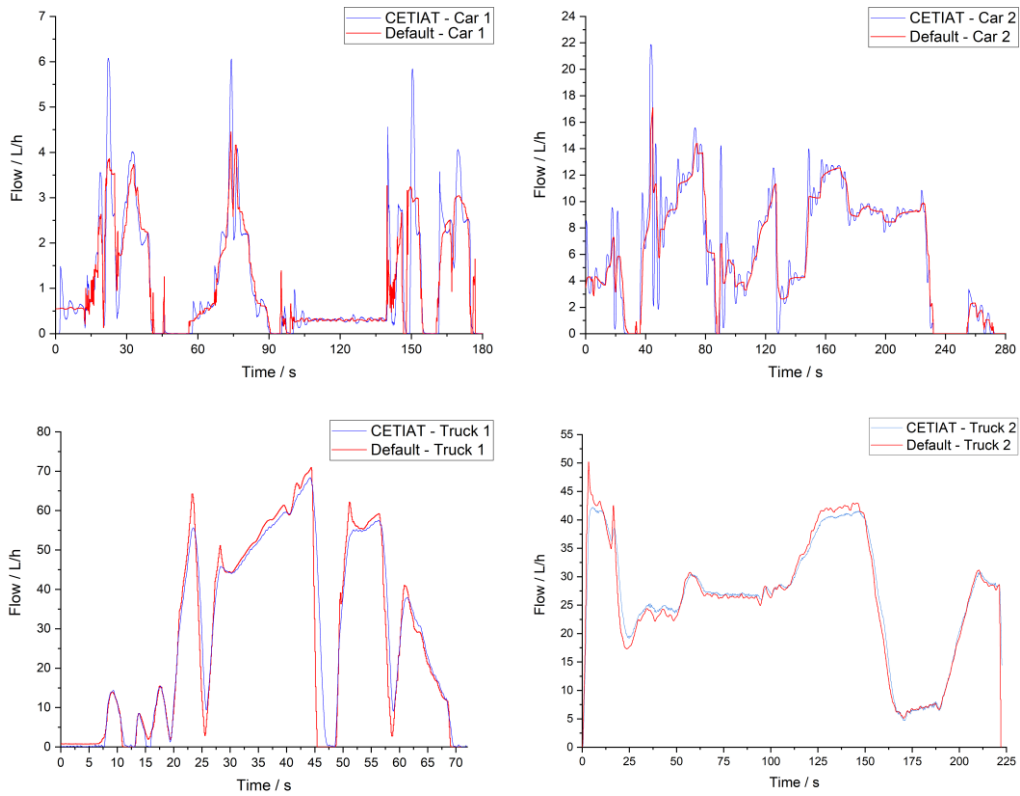

Figure 5: Profile realizations at CETIAT.

4.1.2 NMIJ

Figure 6 shows the realization of the profiles with the prover device of NMIJ [5] at PTB's test benches. Oscillations occur in the two car profiles. It seems that at lower flow rates there is an issue with a fluctuating flow. However, at higher flow rates, as with the truck profiles, the implementation is quite good.

Oscillations also occur with the truck profiles. However, these are smaller than in the car profiles. This suggests that other problems occurred during the generation of the profiles.

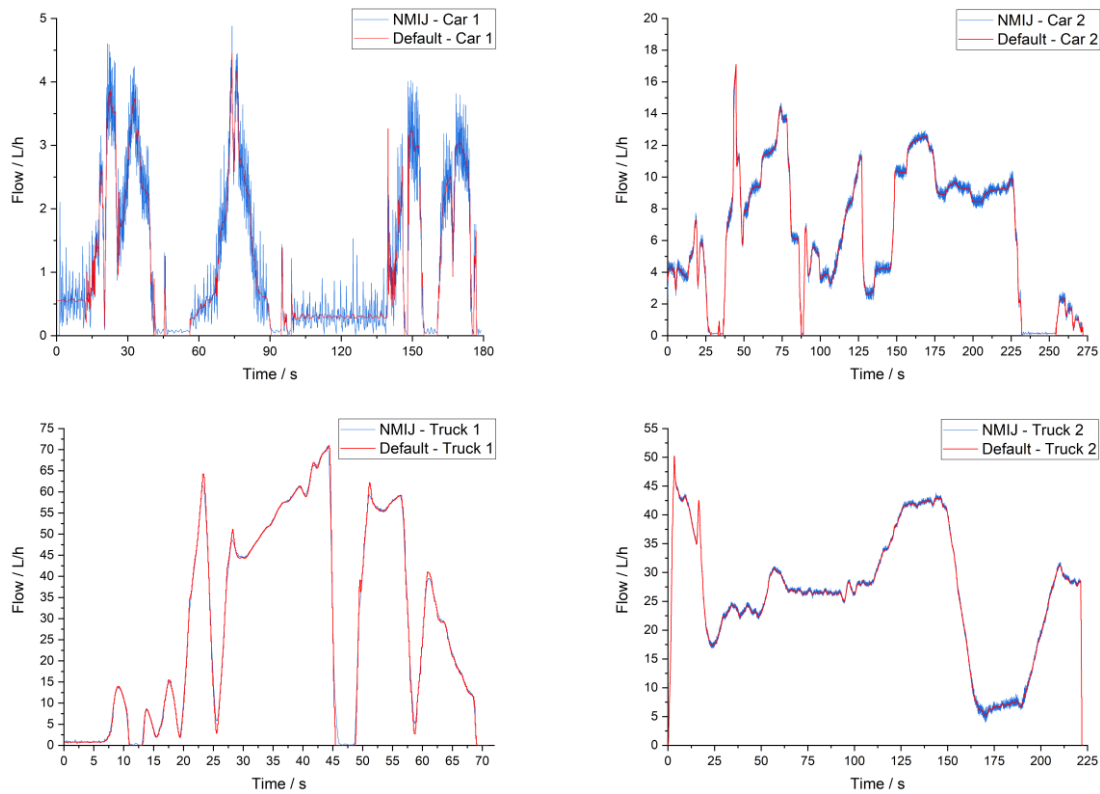

Figure 6: Profile realization NMIJ.

4.1.3 PTB Water

The profile realizations at PTB with water is shown in Figure 7. For the passenger car profile 1, the first change of the nozzle combination results in a high flow rate peak. This flow peak is caused by the change in pressure. After that, the default profile is reproduced well. However, every time the nozzle combination is changed, there is a flow rate peak. This problem is already known from the previous MetroWaMet project. [6] To date, there is no comprehensive solution to avoid these flow peaks. Tests with other valves and expansion vessels did not lead to the required improvements. The passenger car profile 2 and the truck profile 2 have been well realized within the limits of the possibilities of the nozzle technology. This indicates that a considerable number of flow peaks are present, and in certain instances, the achieved flow rate is only marginally different from the default flow. The truck profile 1 is partly well realized. However, in some sections, e.g. between 35 seconds and 40 seconds, it was not possible to generate the specified flow rate due to the limited number of Herschel Venturi nozzles.

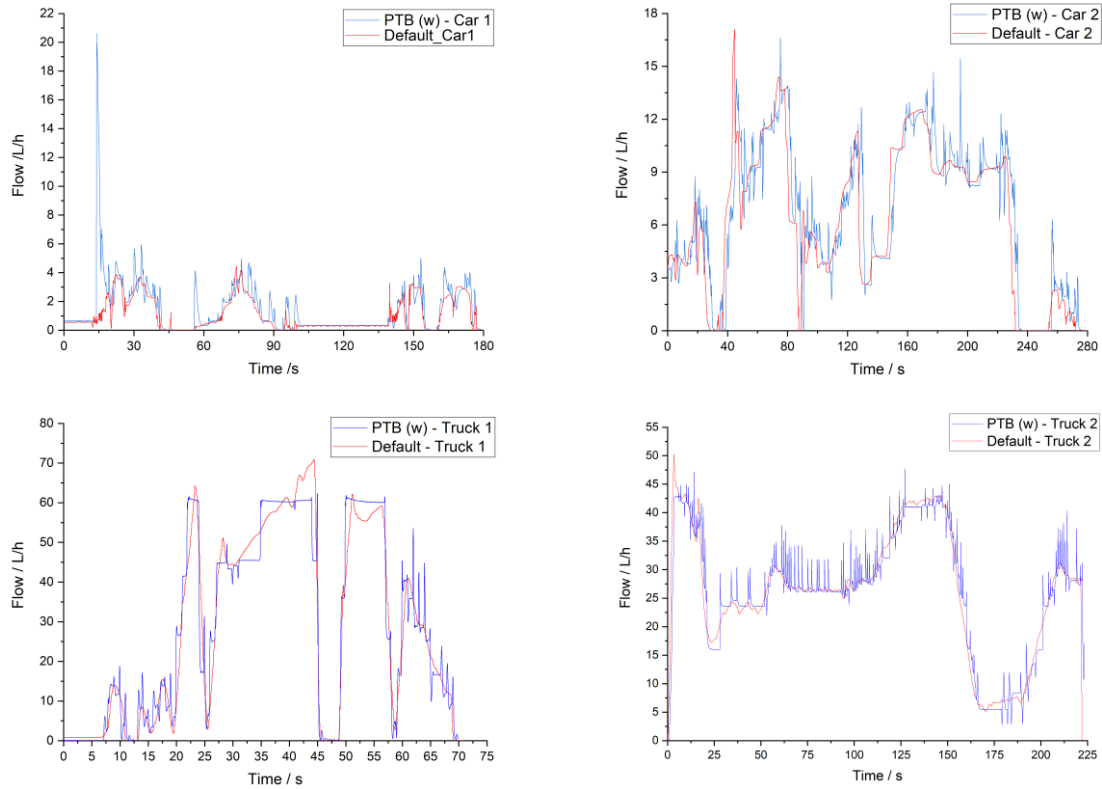

Figure 7: Profile realization PTB water.

4.1.4 PTB oil

The profile realizations at PTB with calibration oil are shown in Figure 8. The profiles were also realized with Herschel Venturi nozzles. In some parts the specified flow rate cannot be realized due to the limited number of nozzles. The flow peaks that occur when using water as test liquid are less noticeable. The passenger car profile 1 demonstrates that the system exhibits inertia at low flow rates, resulting in a prolonged stabilisation period. This phenomenon is particularly evident when the flow rate is reduced. For instance, within the passenger car profile 1, the flow rate remains at a low level for a duration between 38 seconds and 55 seconds, indicating the presence of a residual flow.

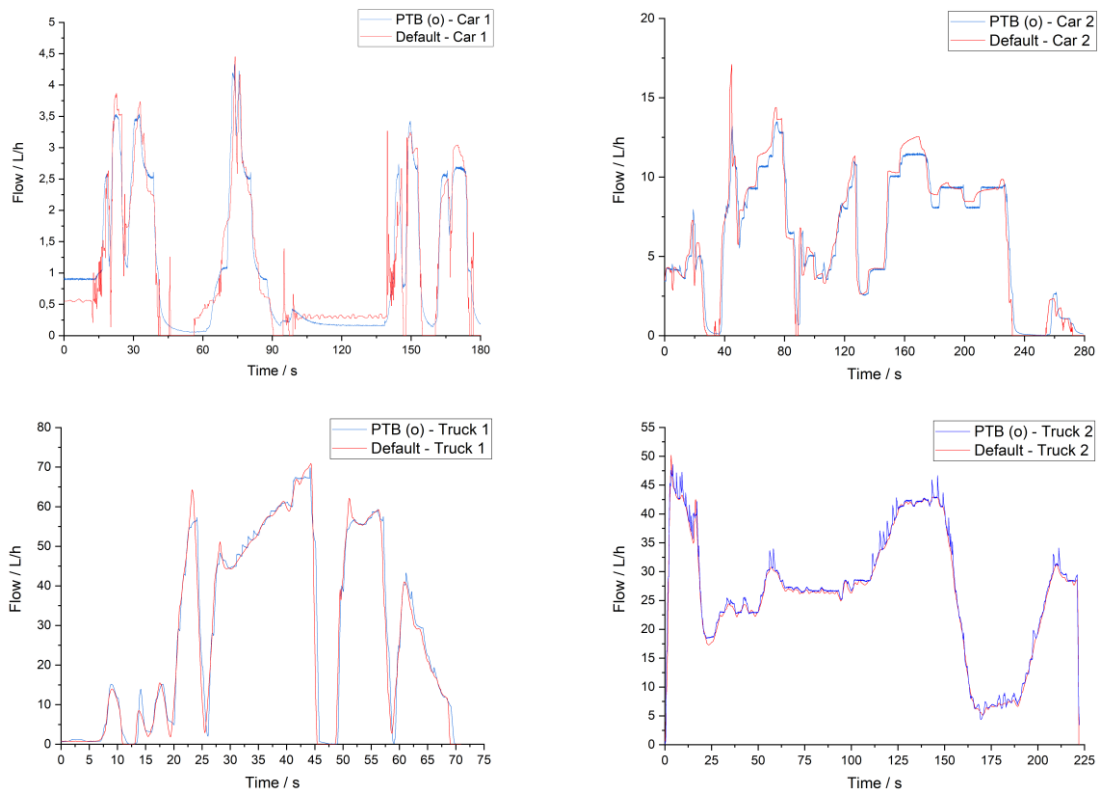

Figure 8: Profile realization PTB oil.

4.1.5 INRIM

Figure 9 shows the INRIM profile realizations. It was not possible to realize the truck profiles on INRIM's test bench due to limitations in the flow rates of the injection nozzles used. The passenger car profiles were also only realized with calibration oil. The results are very good. Both profile realizations follow the default profiles. Only a small oscillation around the specified flow rate occurs.

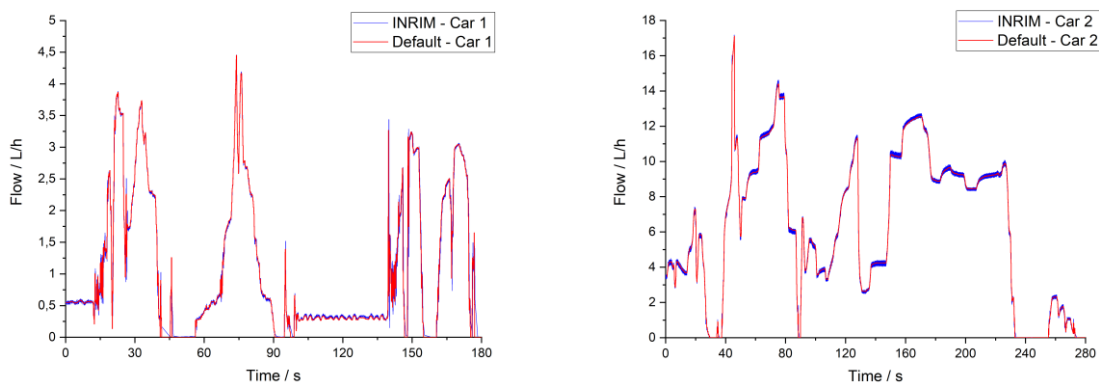

Figure 9: Profile realization INRIM.

4.1.6 UNIPG

Figure 10 shows the profile realizations of UNIPG. It was also only possible to realize the passenger car profiles exclusively with calibration oil here. The results are comparable to the realization at INRIM, where also injection nozzles are used. Vibrations also occur. With the passenger car profile 2, the generated flow rates are slightly higher than the default values. One potential explanation for this

discrepancy is that the calibration of the injectors has not been properly executed. Another additional possible reason could be that the regulation of the flow rate is controlled by the master meter, which could also account for the observed differences in the static measurement.

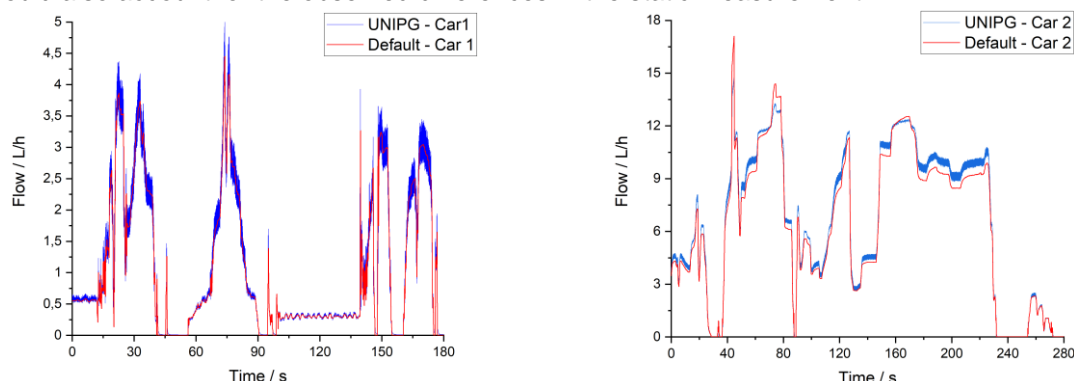

Figure 10: Profile realization UNIPG.

4.1.7 METAS

Due to test bench problems, only the passenger car profile 1 was realized with water. The profile realization is shown in Figure 11. It was not possible to carry out the test with calibration oil due to difficulties with the ventilation of the measuring line. The passenger car profile 1 is very well realized. No oscillations occur.

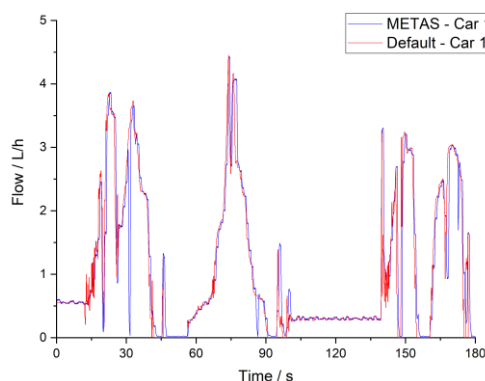

Figure 11: Profile realization METAS.

4.2 Key figures comparison

It was not possible to measure all four profiles at all participants with both, water and calibration oil. In addition, no data is available from the CETIAT reference, which means that not all parameters could be calculated. The same applies to METAS. Due to this not always all parameters specified in section 2.5.3 could be calculated. Table 8 shows the mean values of the parameters obtained for the different participants.

Table 8: Summary of the key parameters of the four profiles for each laboratory.

Institute	Profile	Repeatability / L/h	Mean of residuals / L/h	Deviation of mass ε_D / %	Deviation Coriolis flow meter ε_V / %
CETIAT	Car 1	0.05	0.40	x	x
	Car 2	0.07	0.45	x	x
	Truck 1	1.22	0.50	x	x
	Truck 2	0.34	0.12	x	x
NMIJ	Car 1	0.21	0.07	1.30	0.199
	Car 2	0.26	0.02	0.72	0.043
	Truck 1	0.41	-0.09	0.59	0.083
	Truck 2	0.27	0.08	0.46	0.041
METAS	Car 1	0.08	0.08	x	x
PTB (water)	Car 1	0.04	1.90	37.85	0.942
	Car 2	0.03	0.50	4.31	0.117
	Truck 1	0.18	0.89	1.76	0.263
	Truck 2	0.13	0.21	0.65	0.028
PTB (oil)	Car 1	0.01	0.08	3.38	0.253
	Car 2	0.07	-0.19	-1.61	0.086
	Truck 1	0.47	0.71	2.46	0.581
	Truck 2	0.14	0.61	2.40	0.021
INRIM	Car 1	0.05	0.01	0.12	0.047
	Car 2	0.03	0.01	0.05	0.029
UNIPG	Car 1	0.07	-0.05	1.92	0.127
	Car 2	0.08	0.33	4.39	0.252

Figure 12 to Figure 15 show a graphical summary of the calculated parameters. In an ideal profile generation, the three evaluation criteria would have values of zero. This would correspond to a triangle in the illustrations, as the centre of the graphic is not the origin.

It turns out that injectors are very well suited for generating the passenger car profiles. In particular, the realization with Herschel Venturi nozzles results in large deviations in the total mass. This is due on the one hand to the insufficient number of nozzles to represent all flow points sufficiently well and on the other hand to the flow peaks after a switchover process and the associated settling time. However, a larger number of nozzles would only lead to a limited improvement in the profiles to be realized. Some of the profiles have flow rate changes at intervals of 0.1 s. However, only switching times of more than 1 s can currently be realized with these nozzles satisfactorily.

In terms of repeatability, the NMIJ piston system exhibits the poorest performance for the passenger car profile 1. This is likely attributed to the unintentional oscillations in the flow. All other technologies demonstrate excellent repeatability for the car profiles (standard deviations $\leq 0,08$ %) The standard deviations obtained for the truck profiles are greater than that for the passenger car profiles, indicating that the latter are more repeatable. One reason for this could be that the standard deviation is calculated on the basis of the deviation from the mean profile. The absolute deviation is greater for the truck profiles than for the car profiles, which is a consequence of the greater dispersion of the truck profiles. The CETIAT realizations have the poorest repeatability, while those with Herschel Venturi nozzles and water have the best.

Car 1

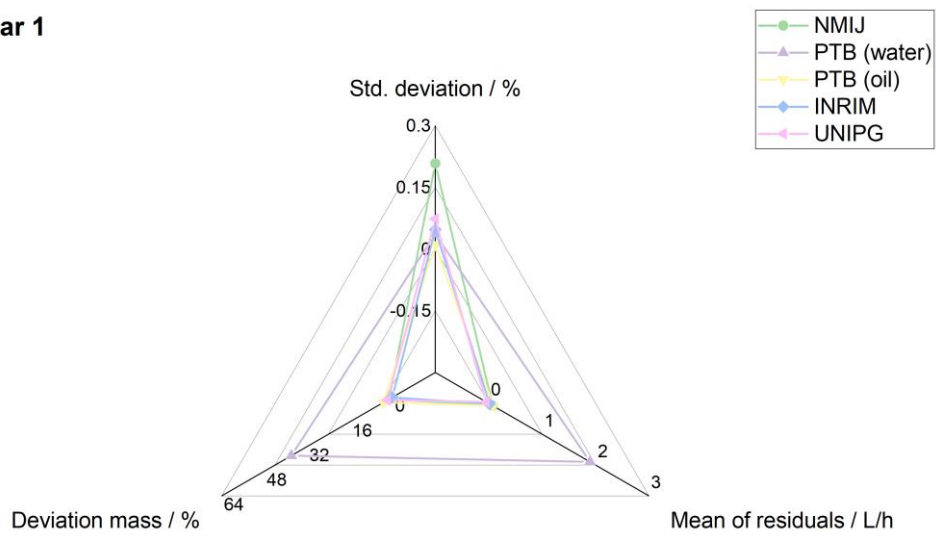

Figure 12: Comparison of the generation of the passenger car profile 1 based on the mean value of the residuals, the deviation of the mass from the specification and the repeatability.

Car 2

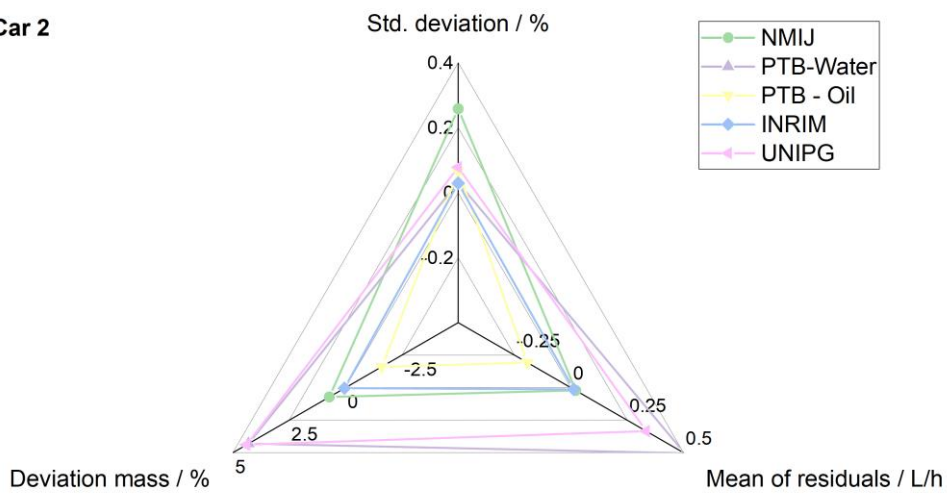

Figure 13: Comparison of the generation of the passenger car profile 2 based on the mean value of the residuals, the deviation of the mass from the specification and the repeatability.

Truck 1

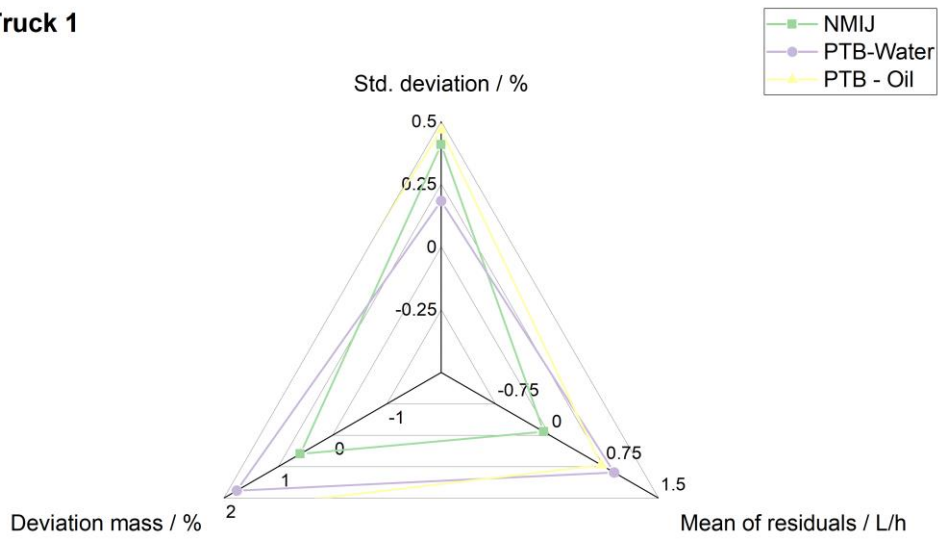

Figure 14: Comparison of the generation of the truck profile 1 based on the mean value of the residuals, the deviation of the mass from the specification and the repeatability.

Truck 2

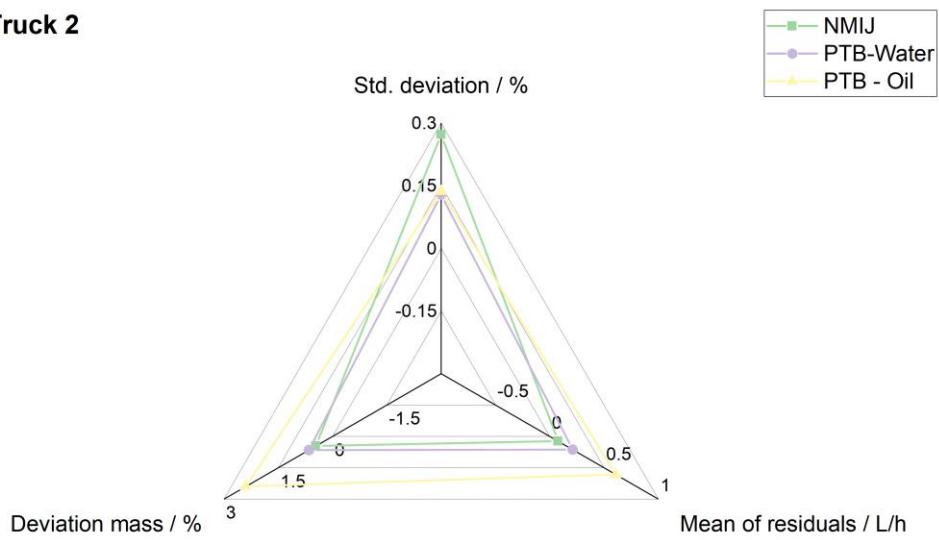

Figure 15: Comparison of the generation of the truck profile 2 based on the mean value of the residuals, the deviation of the mass from the specification and the repeatability.

5 Summary and conclusion

The static measurements for flow rates of less than 10 L/h demonstrate that the zero point of the Coriolis flow meter has a significant impact on the measurement deviation. Furthermore, a discrepancy is observed between the METAS and UNIPG measurements and those of the other participants, which can be attributed to the test benches. A more detailed comparison of the test benches is not feasible due to the limited data available and the significant influence of the zero point of the transfer device in the lower flow rate range.

The comparison of the realizations of the dynamic flow profiles has shown that injection nozzles are very well suited for the generation of dynamic profiles with small flow rates. However, dependencies on the test bench can also be recognized here, as both INRIM and UNIPG use injection nozzles, but the results from INRIM are better in terms of profile realization. So far, however, only the passenger car profiles have been realized, which means that it is not yet possible to assess the technology for profiles with larger flow rates. Further investigations are necessary for this.

The NMIJ's approach of realizing dynamic profiles with a piston system is also well suited. However, this approach is limited in that it is difficult to achieve time periods without flow. At low flow rates, as observed in the passenger car profile 1, the presence of strong vibrations is evident. Consequently, future optimisation work is necessary to address this issue.

Furthermore, Herschel Venturi nozzles are not suitable for the realization of dynamic flow profiles with small, rapidly changing flow rates. Similarly, the realization with fast-switching valves (CETIAT) appears to be suitable only to a limited extent.

6 ANNEX

6.1 Fluid properties

Table 9: Overview of the fluid properties of the calibration oil at the various institutes at 20 °C.

Institute	Density	Viscosity
	kg/m ³	mm ² /s
PTB	819,569	3,6936
INRIM	819.036	3.97
UNIPG	No data available	

6.2 Test bench descriptions

6.2.1 CETIAT

CETIATs dynamic primary standards is based on a gravimetric test rig associated with two dynamic flow generators, installed downstream and upstream of the device under test as shown in Figure 16.

Dynamic flow profiles are generated using a centrifuge pump associated with flow control valves and fast pneumatic valves. Depending on the need, flow changes can be generated either upstream or downstream of the device under test (DUT). Flow changes within one second can be generated within a range from 5 kg/h up to 15000 kg/h. Water temperature is controlled from 12 °C to 90 °C and measured both directly upstream and downstream of the DUT. Pressure upstream of the DUT is controlled within a range of 0.2 barg to 6 barg.

The dynamic mass flow rate is measured using a Sartorius IS150GG weighing scale (150 kg range, 1 g resolution). The flow is entering the weighing scale's reservoir using an immersed pipe equipped with a deflecting plate, which minimizes the effect of the hydrodynamic jet force towards the weighing scale's plate. The dynamic mass flow rate is calculated as the slope of the linear regression on the timestamped mass data. The mass sampling frequency is 1 kHz, which allows for the calculation of the reference mass flow rate over a minimum of 1 second of mass data, up to several hours depending on the calibration point duration. The DUT outputs (either pulses, current, voltage, or digital) are synchronized with the reference flow rate, temperature and pressure measurements using a dedicated acquisition system. The expanded relative uncertainty on the reference flow rate is 0.1 % ($k=2$) for static (constant) flow, 0.2 % ($k=2$) for dynamic (fluctuating) flow.

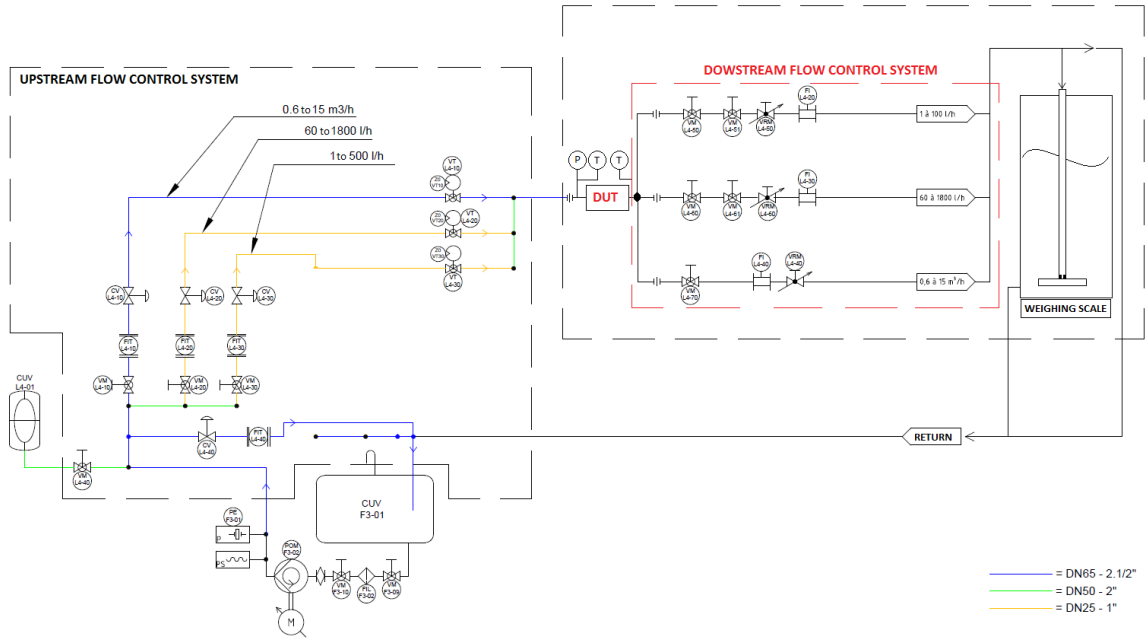

Figure 16: Schematic of Cetiats dynamic test bench.

6.2.2 PTB (water)

The basic experimental setup for the generation of dynamic flow profiles consists of a conventional test bench for static water flow rate measurements against a gravimetric reference (maximum: 35 kg) in which an apparatus with Herschel Venturi nozzles is integrated (Figure 17).

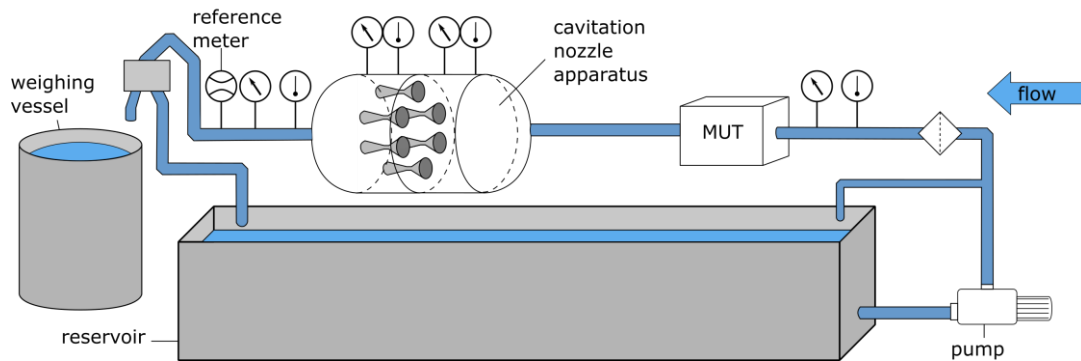

Figure 17: Principal setup of the test bench for measurements using dynamic flow rates at PTB (water).

Static flow is generated by a pump. The flow rate range is between 1 L/h and 200 L/h. Rapidly changing flow rates with quickly stabilizing flows (< 0.1 s) can be generated via the connected cavitation nozzle apparatus (connection by hoses). In the apparatus six cavitation nozzles are integrated, which can be opened and closed by pneumatic valves. The nozzles are exchangeable and using nozzles with different throat diameters variable flows can be generated. The test bench can be used for flow measurements with liquid temperatures in the range of 10 °C to 35 °C. For monitoring purposes, downstream of the measuring section, an additional flow meter, a pressure sensor and a temperature sensor are installed. Two more temperature and pressure sensors are installed upstream. The measurement uncertainty of the test bench for a conventional steady measurement regime is $\pm 0.1\%$ ($k=2$). Temperature stability is ensured by a separate cooling circuit.

Measurements are carried out as follows: In a first step, the test liquid, water, is circulated through the system at a constant flow rate to realize stable measurement conditions. A part of the flow is then diverted from this circuit via a bypass to the measuring section where the meter under test (MUT) is installed. In case of electronic meters their pulse output is used directly. The conversion between volume and mass is done using the current density value, which is determined from bending oscillator measurements. The sampling rate of the system is 300 ms for dynamic measurements.

In addition to the nozzle geometry, the formation of cavitation depends essentially on the ratio of the pressure after the nozzles to the pressure before the nozzles. Therefore, the differential pressure is recorded near the nozzle holders to ensure that the pressure ratio is consistently at 0.75 or below. It was not possible to create stable pressure conditions when creating the profile, which meant that no constant cavitation occurred. Consequently, the decision was taken to operate the nozzles in a non-cavitating state, limiting the flow. More information can be found in [7],[8].

6.2.3 PTB (calibration oil)

The basic experimental setup for the generation of dynamic flow profiles consists of a conventional test bench for static flow rate measurements against a gravimetric reference (maximum: 42 kg) in which an apparatus with cavitation nozzles is integrated (Figure 18). Hydrocarbons are used as test liquid.

Static flow is generated by a pump. Rapidly changing flow rates with quickly stabilizing flows (< 0.1 s) can be generated via the connected cavitation nozzle apparatus (connection by hoses). In the apparatus twelve cavitation nozzles are integrated, which can be opened and closed by electro solenoid valves. The nozzles are exchangeable and using nozzles with different throat diameters variable flows can be generated. The nozzles were operated in a non-cavitating state, limiting the flow.

There are two measuring lines that are used depending on the required flow rate. One measuring line is used for flow rates below 10 L/h. The other measuring line is used for flows between 10 L/h and 300 L/h.

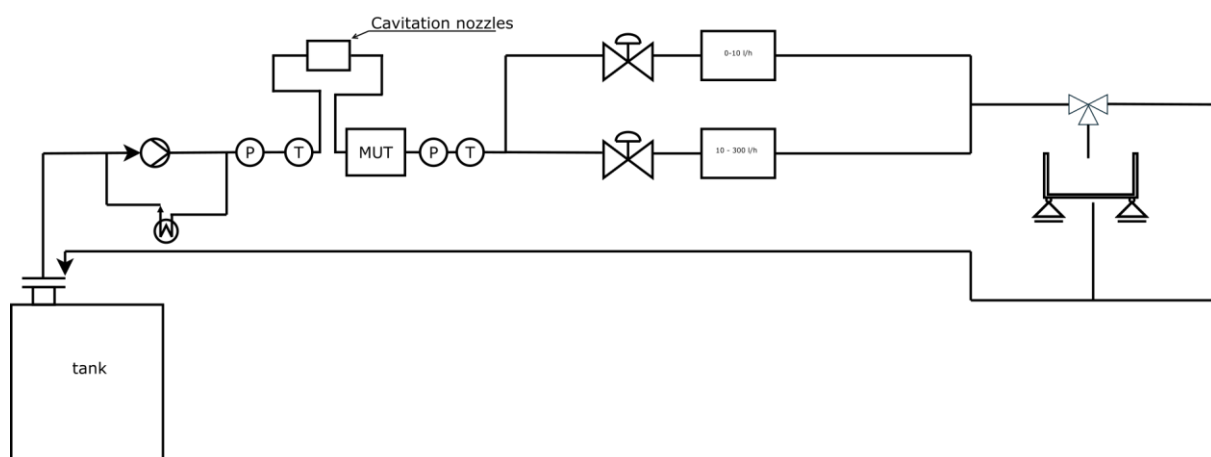

Figure 18: Principal setup of the test bench for measurements using dynamic flow rates at PTB (oil).

6.2.4 INRIM

The test bench at INRIM was developed for the calibration of flow meters at static and dynamic operating conditions with liquids other than water. At present the liquid in use is the oil FUCHS VISCOR1487 AW-2, which complies with the ISO standard 4113 for calibration liquids.

The bench is based on the gravimetric method and the layout of the bench is schematically illustrated in Figure 19.

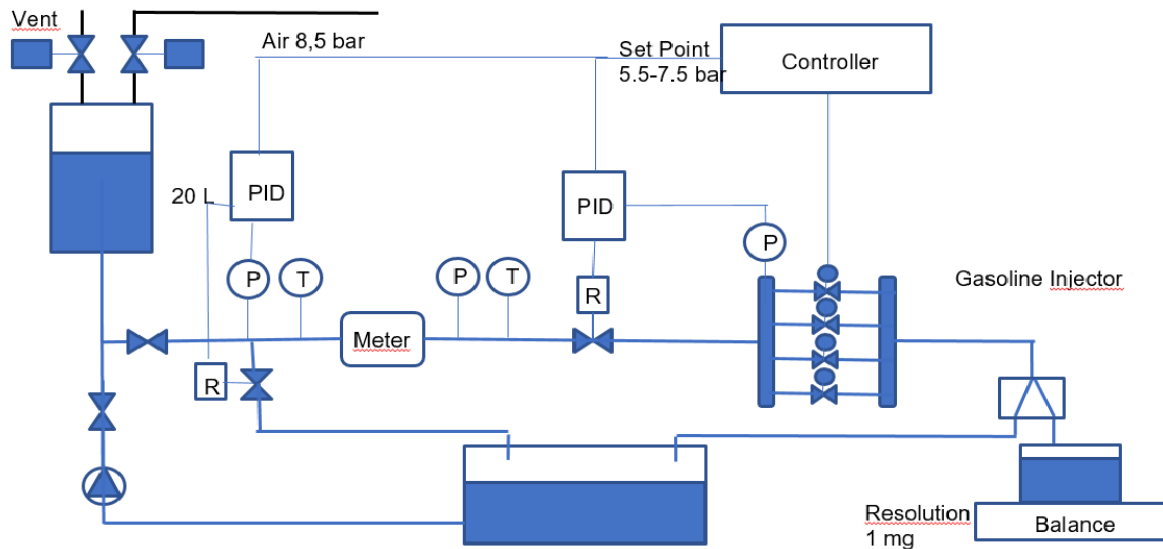

Figure 19: The INRIM test bench for flow meter calibrations.

Pressure is generated using a pressure vessel of 20 L, the pressure of which is kept constant. Additional control valves located upstream and downstream of the flow meter can be used to keep the oil pressure constant.

Downstream of the flow meter to be calibrated there are four gasoline injectors whose function is to generate the dynamic flow rate profiles. The test bench can be operated in two different modes: “standing start and stop” and “flying start and stop”. The method is defined by the use of the diverter. The balance has a capacity of 10 kg with a resolution of 1 mg. The bench is equipped with various thermometers and pressure transducers. Their position can be seen in Figure 19. The test bench is controlled by a National Instrument system and the control software was developed in a LabVIEW environment.

The injectors are controlled by an NI module 9401, which allows the frequency and duty cycle of the four injectors to be adjusted. With this configuration the flow rate can be adjusted as a function of the drop pressure and the opening time of the injectors. The injector opening time is not exactly the same as the supply time. Factors that influence the opening and closing time of the injector include the mechanical design of the injector (stem, spring, etc.), the electrical delay and the hydraulic delay. The latter depends on the injection process conditions such as injection pressure and back pressure.

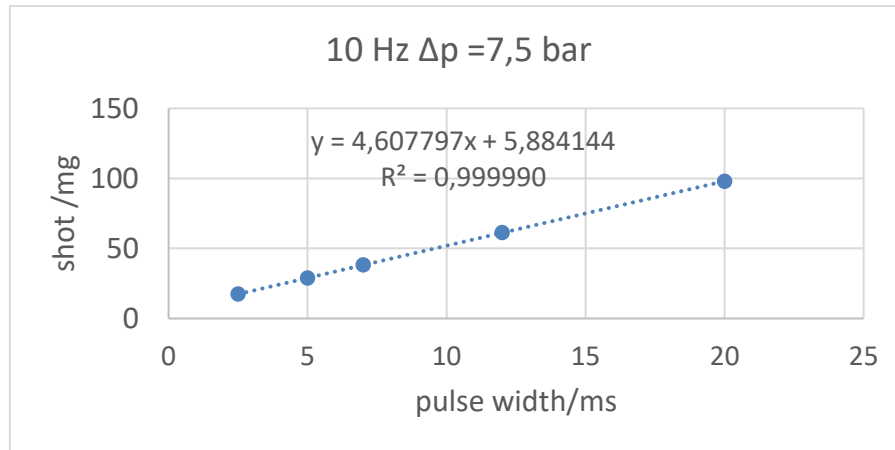

Figure 20: Calibration example.

The calibration of the injectors can be performed by the balance for different operating frequencies and duty cycles. An example of a calibration is given in **Fehler! Verweisquelle konnte nicht gefunden werden..**

With regard to the realization of fuel consumption profiles e.g. for passenger cars, the approach is to control the injectors with a constant frequency of 20 Hz. Only for small flow rates below 0.4 kg/h the control frequency is 15 Hz. For the injectors used, the maximum flow rate for each injector is about 8 kg/h at an inlet pressure of about 4.5 bar. Depending on the section of the profile the generation can be performed using a single injector (e.g. for passenger car profile 1, Figure 1) or two injectors are required. For passenger car profile 2 (Figure 1), only one injector is used up to 7 kg/h, and two for higher flow rates. The calibration of the two injectors used for flow rates above 7 kg/h is carried out by controlling both injectors simultaneously.

After determining the calibration curves for the single injector and the pair of injectors, it is possible to calculate the duty cycle of each injector for each flow rate to generate the profile, provided that the operating conditions of pressure and temperature are the same as the calibration conditions. The software based on the data of the profile flow rate and the calibration curves generates two tables with the values of the frequencies and duty cycles for each injector. These data have a timing of 100 ms, the same as the profile. If the initial flow rate is not zero, the injectors are controlled to generate the initial flow rate. At the start of the test the diverter is switched to the balance, then the required frequency and duty cycle values are sent to the injector control system with a timing of 100 ms. At the end of the test, the injectors are switched off and the diverter is switched to the storage tank.

6.2.5 UNIPG

At the SprayLAB of the University of Perugia a Dynamic Hydraulic Test Bench (DHTB) has been developed to test and calibrate both, injection systems and instrumentation such as sensors and flow meters. Both, static and dynamic flow operating conditions can be implemented. The main features of the bench are:

- Complete injection systems can be installed, consisting of low- and high-pressure pump, rail, connecting pipes and injectors;
- Diesel, GDI and PFI injection systems can be analysed (max. pump power 10 kW);

- The installed injection system can be operated in steady-state conditions or following a prescribed time-dependent profile for speed/pressure/injection strategy;
- In Diesel configuration, both injected fuel flow rate and the back leak flow rate can be measured by 2 Coriolis mass flow meters (Siemens MASS2100 DI1.5);
- Other quantities can also be acquired, e.g. pump torque, rail/pipe pressure, injector current. As a special measurement add-on, the injection rate produced by one of the injectors in the system can be analysed using a proprietary injection analyzer based on the Zeuch Method;
- The test bench control software has been developed in LabVIEW at UNIPG and can be customized to specific requirements.

Test bench description

The DHTB was used as a dynamic flow generator to calibrate a Coriolis mass flow meter, analysing the actual capability of the meter to dynamically and accurately follow the time-varying flow rate. The flow profile generated by the test bench was one of the profiles shown in Figure 1. A standard test fluid (FUCHS VISCOR1487 AW-2) compliant with the widely adopted ISO-4113 rule was used in the tests.

In Figure 21 a schematic of the test bench arrangement used for the testing is shown. The hydraulic circuit is fed by an electric low-pressure pump (nominal features: 300 L/h at 6 bar). The fluid pressure in the circuit is regulated by a precision mechanical regulator, which returns part of the pressurized flow to the tank. The pressurized test fluid is fed to a common rail where both fluid temperature and pressure are monitored (by a K-type thermocouple and a Honeywell PX3 10bar, 1% f.s. accuracy, respectively). The common rail feeds up to four PFI injectors (Continental Type72351 in this application). Depending on the required flow rate a different number of the installed injectors can be activated.

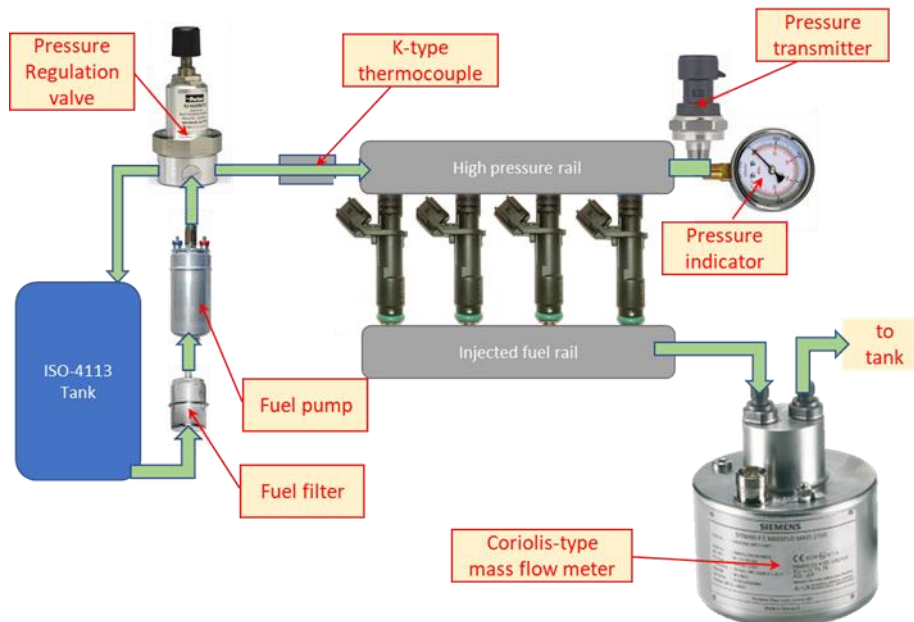

Figure 21: Schematic of the Dynamic Hydraulic Test Bench used.

The injected fluid is collected by a second common rail from which the fluid is collected to the mass flow meter under test/calibration, currently a Siemens MassFlow2100 DI 1.5 (master meter). In **Fehler! V erweisquelle konnte nicht gefunden werden.**, a photo of the implemented system can be seen.

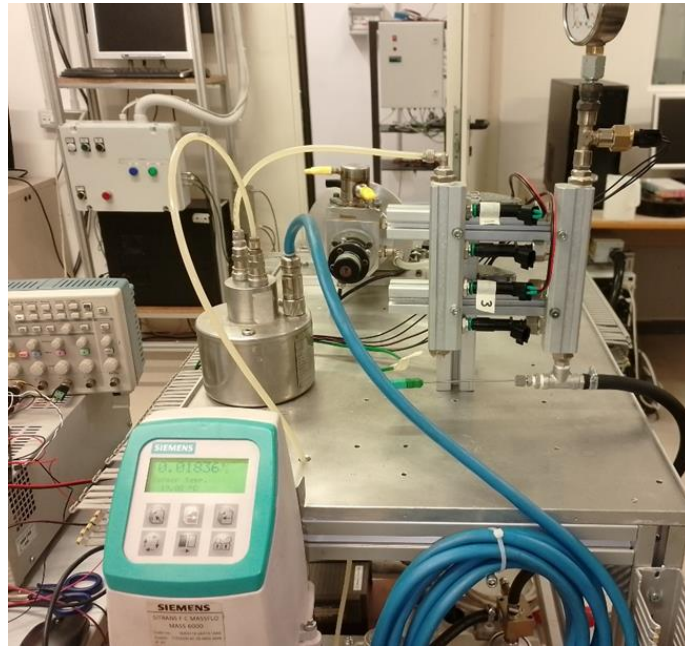

Figure 22: The dynamic hydraulic test bench at UNIPG.

Two particular features of the test bench are worth mentioning:

- A vertical arrangement of the downstream common rail has been chosen, by this to facilitate the evacuation of any eventual air or vapor bubbles that may form in the circuit, thus improving the stability of the Coriolis mass flow meter signal.
- In order to limit the delay in the flow meter signal with respect to any change of the injection strategy (frequency and/or activation time), a relatively small volume of the circuit has been implemented downstream of the injectors. To this end, the internal volume of the downstream rail was reduced to about 7 cm^3 and to connect it with the flow meter inlet a 250 mm long, 4 mm internal diameter pipe was used (about 3.14 cm^3).

The bench control system is based on proprietary software developed in a LabVIEW environment and National instrument multi-function boards. The control system consists of:

- a PCI-6602, 8-counter board used to generate TTL logic commands for driving up to 4 injectors, freely controlling frequency, duration and relative phase of the pulses. In order to produce a relatively smooth flow rate through the flow meter, the injector pulses are spaced evenly in time. The injection pulses are used to control the injector power drivers, which are based on TIP121 Darlington.
- a PCI-6221 multi-function acquires analog and digital signals from the field (flow rate, density, rail pressure, fuel temperature). In particular, the mass flow rate analog signal is acquired during the test (0-20 mA) with the cut-off set to zero. By default, the zeroing procedure was actuated just prior to each test start, with an instrument warm-up of 1 hour.

The system is operated with 1 or 2 injectors depending on the target maximum flow rate in the test; the target rail pressure level is set to 4 barg.

Bench Control Strategy

Different control strategies can be implemented to produce a prescribed flow time-profile:

- a) Injection frequency is constant; Energizing Time (ET) is varied to produce the requested flow;
- b) Energizing Time (ET) is constant; the injection frequency is varied to produce the requested flow;
- c) Both, energizing Time (ET) and actuation frequency are varied to produce the requested flow time-history.

Strategy c) can be conveniently implemented when data is available from an real engine, in terms of rpm (actuation frequency), injector current time (ET) and injection pressure (P_{inj}). Normally, this approach leads to good results in terms of flow rate control capability as in the engine management system follows the most appropriate operating condition in terms of ET and P_{inj} to keep the injectors in their linear operating range.

When a complete engine dataset is not available, either strategy a) or b) must be implemented. In the following, the a) strategy is assumed. The following steps are therefore taken to define the bench control procedure:

1. The injectors are individually characterized so to determine the mean injected quantity per actuation as a function of the actuation signal duration (ET). Typically, two operation zones can be identified in the resulting EMI curve. For very short ET durations, the ballistic mode is obtained, where a non-linear correlation between the duration of actuation command duration and the mean injected quantity is obtained due to a partial rise of the injector needle. For longer command durations, the needle reaches its fully open position and a linear function of the mean injected quantity is obtained from the ET duration.
2. From the target flow rate curve, the number of injectors to be used and the injection frequency are set, thus calculating the mass to be injected per operating cycle and per injector.
3. By interpolating the EMI curve, the sequence of ET values is determined.
4. The injectors characterization – step 1 - is crucial. Significant differences are usually obtained by changing the actuation frequency. As an example, in Fig. 22 (left) the results obtained for a single injector operated at 10 Hz and 50 Hz are shown. As can be seen, the different thermal loads applied to the injector solenoid when actuated at different frequencies change the coil resistance, resulting in a significantly lower mean mass flow rate at higher actuation frequency.

Figure 23 (right) shows the characterization of two injectors, demonstrating the importance of performing the hydraulic analysis for each single injector in order to account for the individual dispersion. Consequently, tests have been carried out with a minimum number of injectors, operated with a relatively long actuation ET to minimize the effects of ballistic operation. Where appropriate, a constant frequency strategy should be used to actuate the injector to control the bench flow rate. The reference EMI curve should be acquired at the same frequency.

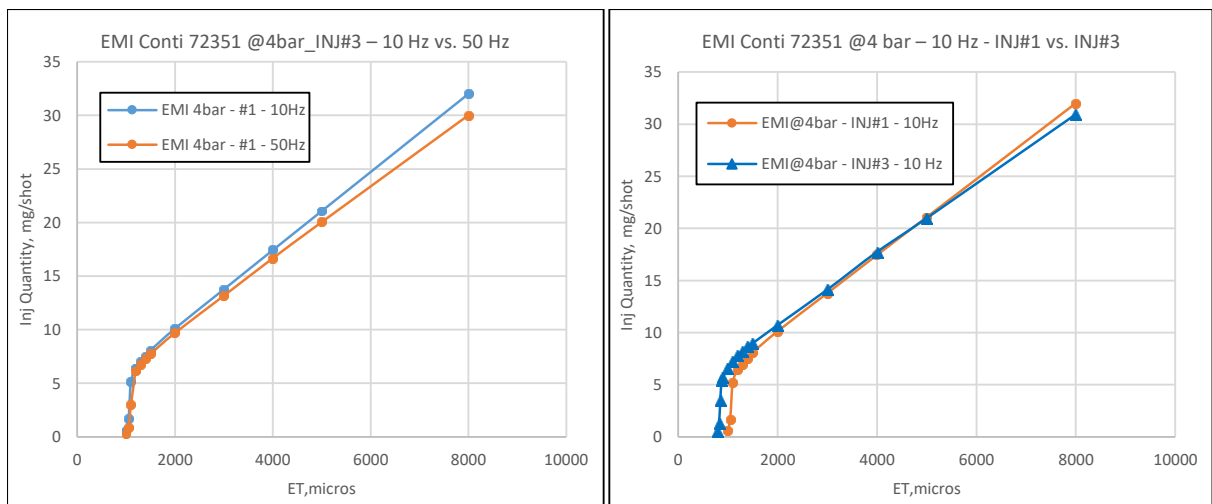

Figure 23: Injector characterization - EMI curves.

Results and comments

In Figure 24 some results relevant to a complete WLTP test cycle are summarized. In this specific case, the availability of both the injection frequency and the ET schedule allows a significant agreement with the target flow rate history (measured at the engine). In total, a delay of about 1.2 s was observed for the bench flow time history with respect to the trend measured on the engine. As can be seen from the zoom of Figure 24 shown in **Fehler! Verweisquelle konnte nicht gefunden werden.**, there is considerable room for improvement:

- 1) inaccuracy in idle conditions;
- 2) delay in replicating zero-flow conditions;
- 3) inability to follow peak flow rate values.

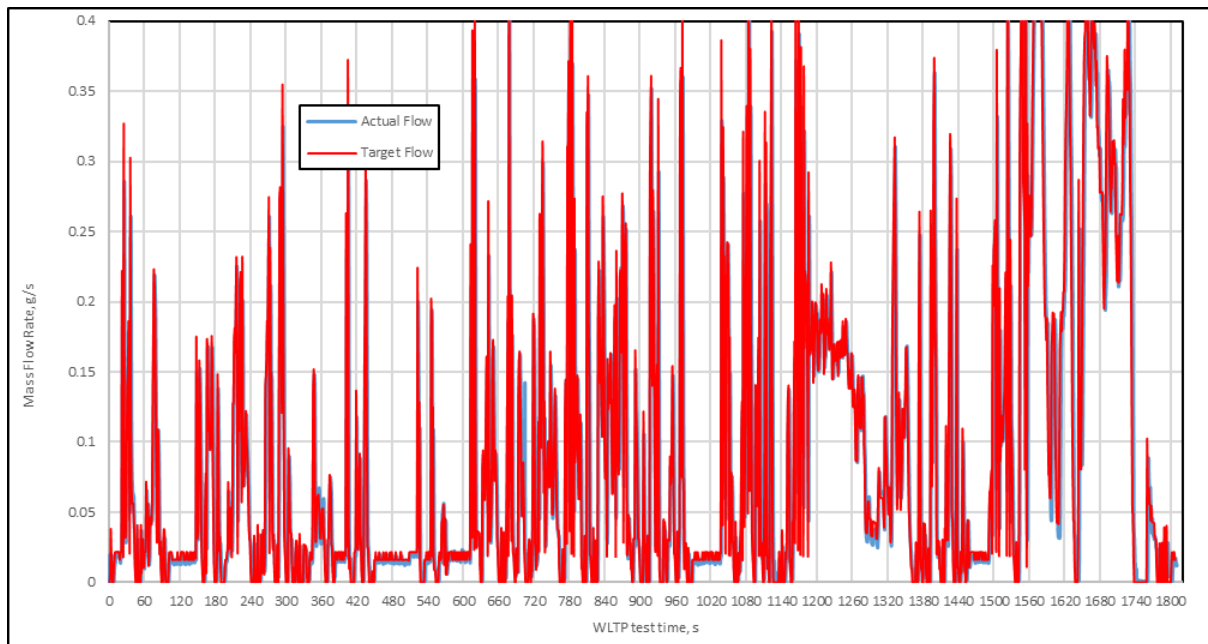

Figure 24: Actual vs. target flow time profiles, obtained with c) strategy.

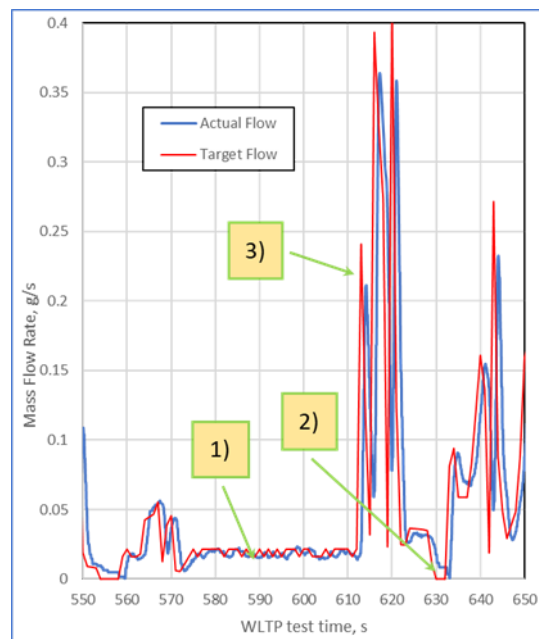

Figure 25: Actual vs. target flow profile obtained with a) strategy; Zoom of Figure 24.

2) and 3) issues can probably be attenuated further reducing the downstream rail volume, i.e. reducing the hydraulic inertia of the system.

Figure 26 illustrates the capability of the UniPG DHTB to reproduce the passenger car profile 1 (A2). In this case, the strategy a) was used with an injection frequency of 25 Hz. Despite the overall appreciable capability to reproduce the target profile, some inaccuracies were observed:

- 1) at low flow conditions;
- 2) difficulty in obtaining the peak flow rate values.

In this case, as in the previous one, a reduction in the mass and inertia of the fluid system between the injector and the Coriolis flow meter should be beneficial to improve the accuracy in reproducing the target flow rate history.

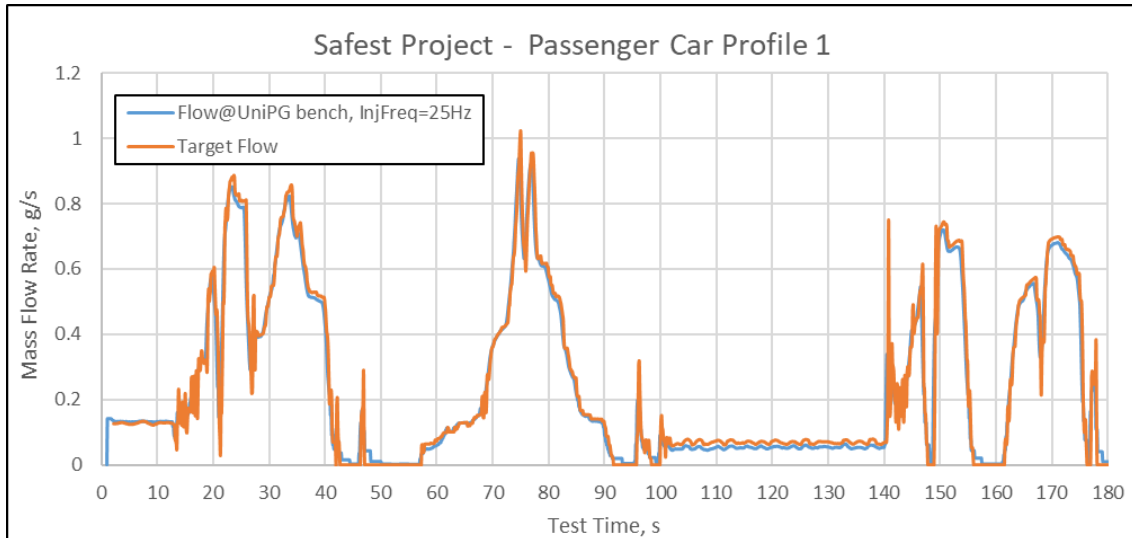

Figure 26: Realization of the Passenger Car Profile 1 with the UNIPG test bench.

Further Steps

The following actions will be implemented to improve the dynamic hydraulic test bench capability to reproduce a prescribed flow rate time profile, thus consolidating its use as a calibration tool for mass flow meters under dynamic conditions:

- Improvements in the injector calibration at low to moderate flow rates;
- Implementation of a new control strategy, based on constant injection frequency for high to intermediate flow rates. Below a given flow rate, a reduction of the actuation frequency will then be applied to limit of the injectors in ballistic conditions operation;
- Reduction of the liquid volume downstream the injectors to the Coriolis meter inlet;
- Implementation of a gravimetric reference downstream of the Coriolis flow meter for the dynamic tests, in order to control the overall mass flowing in the measuring system.

6.3 Overview of the measurement results

6.3.1 Static measurements

Table 10: Measurement results PTB - water

PTB – water					Measurement error					
Nominal flow rate	Lab uncertainty $k = 1$	Average flow rate	Average upstream pressure	Average Water temperature	Average	stand. dev.	Number of single measurements	uRepeat $k = 1$	uTS $k = 1$	u(xi) $k = 1$
L/h	%	L/h	bar	°C	%	%	-	%	%	%
1	0.050	0.95	3.0	20.8	0.101	0.017	5	0.008	0.12	0.133
5	0.050	4.98	3.0	19.7	-0.007	0.003	5	0.001	0.03	0.057
10	0.050	10.02	3.0	19.5	0.001	0.004	5	0.002	0.02	0.053
20	0.05	20.10	3.0	19.4	0.007	0.003	5	0.001	0.01	0.051
60	0.05	60.41	3.0	19.3	0.027	0.002	5	0.001	0.01	0.051
100	0.05	100.68	3.5	19.4	0.037	0.003	5	0.001	0.00	0.050

Table 11: Measurement results METAS - water

METAS – water					Measurement error					
Nominal flow rate	Lab uncertainty $k = 1$	Average flow rate	Average upstream pressure	Average Water temperature	Average	stand. dev.	Number of single measurements	uRepeat $k = 1$	uTS $k = 1$	u(xi) $k = 1$
L/h	%	L/h	bar	°C	%	%	-	%	%	%
0.25	0.035	0.250	-0.001	21.98	0.50	0.03	6	0.013	0.14	0.149
0.5	0.035	0.500	0.02	22.11	0.305	0.015	6	0.006	0.14	0.149
1	0.035	0.999	0.04	22.2	0.218	0.022	6	0.009	0.12	0.128
5	0.035	4.999	0.32	22.5	0.123	0.014	6	0.006	0.03	0.045
10	0.035	9.997	0.84	22.4	0.124	0.013	6	0.005	0.02	0.039

Table 12: Measurement results INRIM - water

INRIM – water					Measurement error					
Nominal flow rate	Lab uncertainty $k = 1$	Average flow rate	Average upstream pressure	Average Water temperature	Average	stand. dev.	Number of single measurements	uRepeat $k = 1$	uTS $k = 1$	u(xi) $k = 1$
L/h	%	L/h	bar	°C	%	%	-	%	%	%
0.25	0.085	0.25	2.00	22.0	-0.154		5		0.14	0.168
0.5	0.050	0.5	2.50	22.0	-0.150		5		0.14	0.153
1	0.035	1.00	1.0	22.0	-0.080		5		0.12	0.128
5	0.025	4.97	3.0	22.0	-0.019		5		0.03	0.037
10	0.020	10.00	2.5	22.0	-0.010		5		0.02	0.026
20	0.02	20.02	2.5	22.0	-0.007		5		0.01	0.023
60	0.02	60.02	2.5	22.0	0.014		5		0.01	0.021
100	0.02	100.03	3.0	22.0	0.027		5		0.00	0.020

Table 13: Measurement results PTB - oil

PTB – oil					Measurement error					
Nominal flow rate	Lab uncertainty $k = 1$	Average flow rate	Average upstream pressure	Average Water temperature	Average	stand. dev.	Number of single measurements	uRepeat $k = 1$	uTS $k = 1$	u(xi) $k = 1$
kg/h	%	L/h	bar	°C	%	%	-	%	%	%
0.25	0.10	0.3	3.01	21.18	-1.07	0.18	5	0.081	0.14	0.194
0.5	0.10	0.5	3.01	21.05	-0.687	0.090	5	0.040	0.14	0.180
1	0.10	1.01	3.0	21.3	-0.435	0.009	5	0.004	0.07	0.123
5	0.05	5.03	3.0	21.1	-0.113	0.030	5	0.013	0.02	0.055
10	0.05	10.05	3.0	21.4	-0.055	0.006	5	0.003	0.002	0.050
20	0.05	20.05	3.0	21.4	-0.032	0.017	5	0.007	0.004	0.051
60	0.05	60.20	3.0	21.2	0.006	0.006	5	0.003	0.03	0.056
100	0.05	100.29	3.0	21.2	0.030	0.004	5	0.002	0.03	0.061

Table 14: Measurement results INRIM - oil

INRIM – oil					Measurement error					
Nominal flow rate	Lab uncertainty $k = 1$	Average flow rate	Average upstream pressure	Average Water temperature	Average	stand. dev.	Number of single measurements	uRepeat $k = 1$	uTS $k = 1$	u(xi) $k = 1$
L/h	%	kg/h	bar	°C	%	%	-	%	%	%
0.25	0.085	0.22	4.50	23.20	0.59	0.04	5	0.020	0.14	0.169
0.5	0.050	0.4	4.50	23.50	0.359	0.032	5	0.014	0.14	0.153
1	0.035	0.83	4.8	23.8	0.182	0.033	5	0.015	0.07	0.081
5	0.025	4.14	4.8	21.0	0.040	0.022	5	0.010	0.02	0.033
10	0.020	8.14	5.0	20.8	0.033	0.024	5	0.011	0.002	0.023
20	0.02	16.32	5.0	19.1	0.024	0.007	5	0.003	0.004	0.021
60	0.02	49.10	4.8	19.2	0.031	0.010	5	0.004	0.03	0.032
100	0.02	82.01	4.8	19.2	0.151	0.026	5	0.012	0.03	0.041

Table 15: Measurement results UNIPG - oil

UNIPG – oil					Measurement error					
Nominal flow rate	Lab uncertainty $k = 1$	Average flow rate	Average upstream pressure	Average Water temperature	Average	stand. dev.	Number of single measurements	uRepeat $k = 1$	uTS $k = 1$	u(xi) $k = 1$
L/h	%	kg/h	bar	°C	%	%	-	%	%	%
0.25	0.100	0.21	3.00	20.07	1.27	0.26	5	0.117	0.14	0.211
0.5	0.100	0.4	3.00	20.74	0.190	1.643	5	0.735	0.14	0.755
1	0.100	0.82	3.0	23.2	0.541	2.417	5	1.081	0.07	1.088
5	0.100	4.12	3.0	25.5	0.399	0.601	5	0.269	0.02	0.287
10	0.100	8.25	3.0	21.9	0.279	0.269	5	0.120	0.002	0.156
20	0.100	16.49	3.0	22.9	0.511	0.119	5	0.053	0.004	0.113

6.3.2 Dynamic measurement

Table 16: Measurements results of METAS (water).

Profile	Av. Error	U(k=2)	Av. Temperature	Av. Pressure
	%		°C	barg
Car 1	?	0.07	22.29	1.37
Car 2	Not measured			
Truck 1				
Truck 2				

Table 17: Measurements results of PTB (water).

Profile	Av. Error	U(k=2)	Av. Temperature	Av. Pressure
	%		°C	barg
Car 1	0.94	0.1	20.52	0.08
Car 2	0.12	0.1	20.67	0.12
Truck 1	0.26	0.1	19.92	0.38
Truck 2	0.03	0.1	19.62	0.38

Table 18: Measurements results of CETIAT (water).

Profile	Av. Error	U(k=2)	Av. Temperature (°C)	Av. Pressure (barg)
Car 1	Not data available		20.72	3.45
Car 2			19.65	2.91
Truck 1			21.12	3.50
Truck 2			21.08	2.03

Table 19: Measurements results of NMIJ (water).

Profile	Av. Error	U(k=2)	Av. Temperature	Av. Pressure
	%		°C	barg
Car 1	0.20	0.1	20.11	0.09
Car 2	0.04	0.1	20.1	0.13
Truck 1	0.08	0.1	19.63	0.54
Truck 2	0.04	0.1	19.7	0.40

Table 20: Measurements results of PTB (oil).

Profile	Av. Error	U(k=2)	Av. Temperature (°C)	Av. Pressure (barg)
Car 1	0.26 %	0,1	22.48	1.99
Car 2	0.10 %	0,1	21.84	1.94
Truck 1	0.27 %	0,1	22.08	2.01
Truck 2	-0.03 %	0,1	21.88	2.01

Table 21: Measurements results of INRIM (oil).

Profile	Av. Error	U(k=2)	Av. Temperature	Av. Pressure
	%		°C	barg
Car 1	0.05		23.03	4.47
Car 2	0.03		22.54	4.47
Truck 1	Not measured			
Truck 2				

Table 22: Measurements results of UNIPG (oil).

Profile	Av. Error	U(k=2)	Av. Temperature	Av. Pressure
	%		°C	barg
Car 1	-1.88		19.65	0.14
Car 2	0.47		24.13	0.25
Truck 1	Not measured			
Truck 2				

6.4 Distribution of residuals

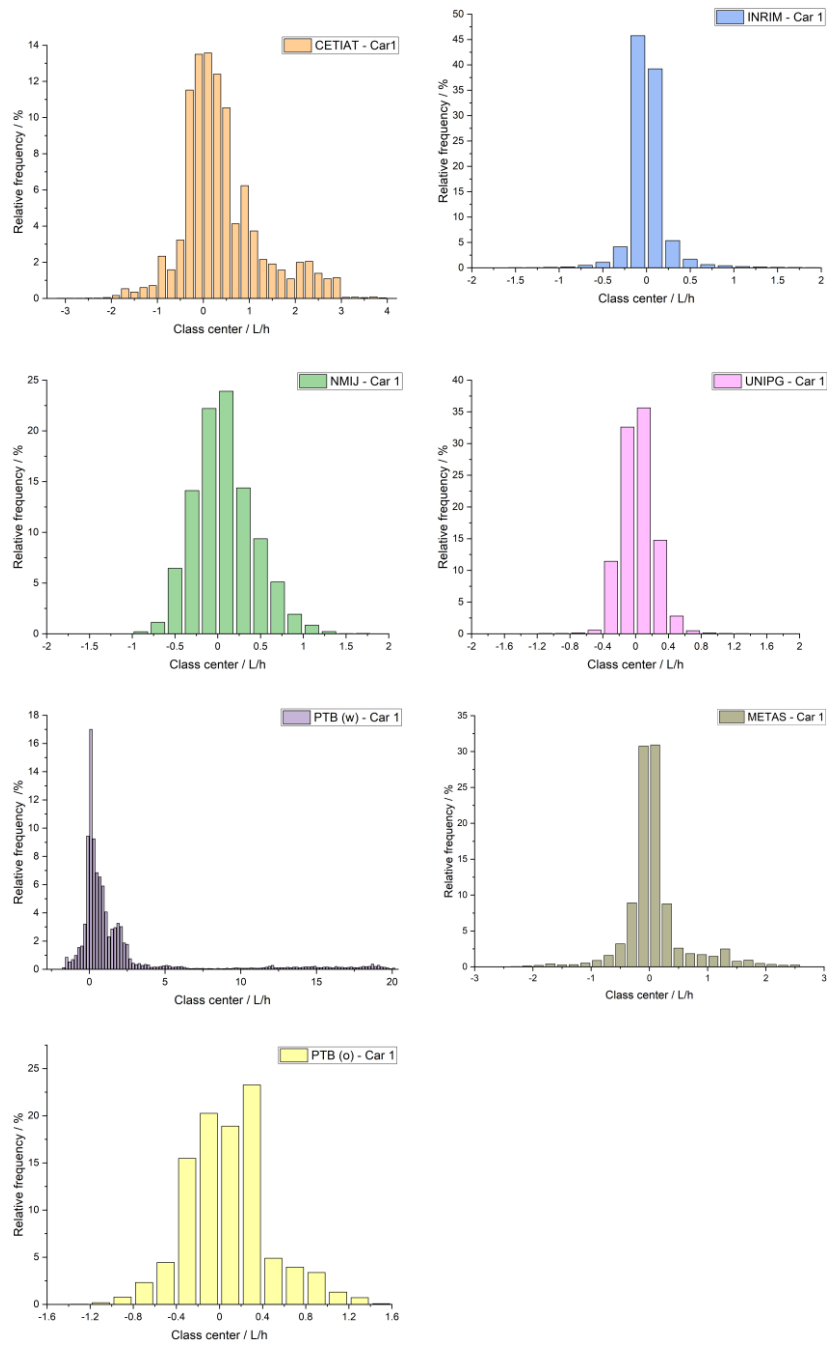

Figure 27: Distribution of residuals for passenger car profile 1.

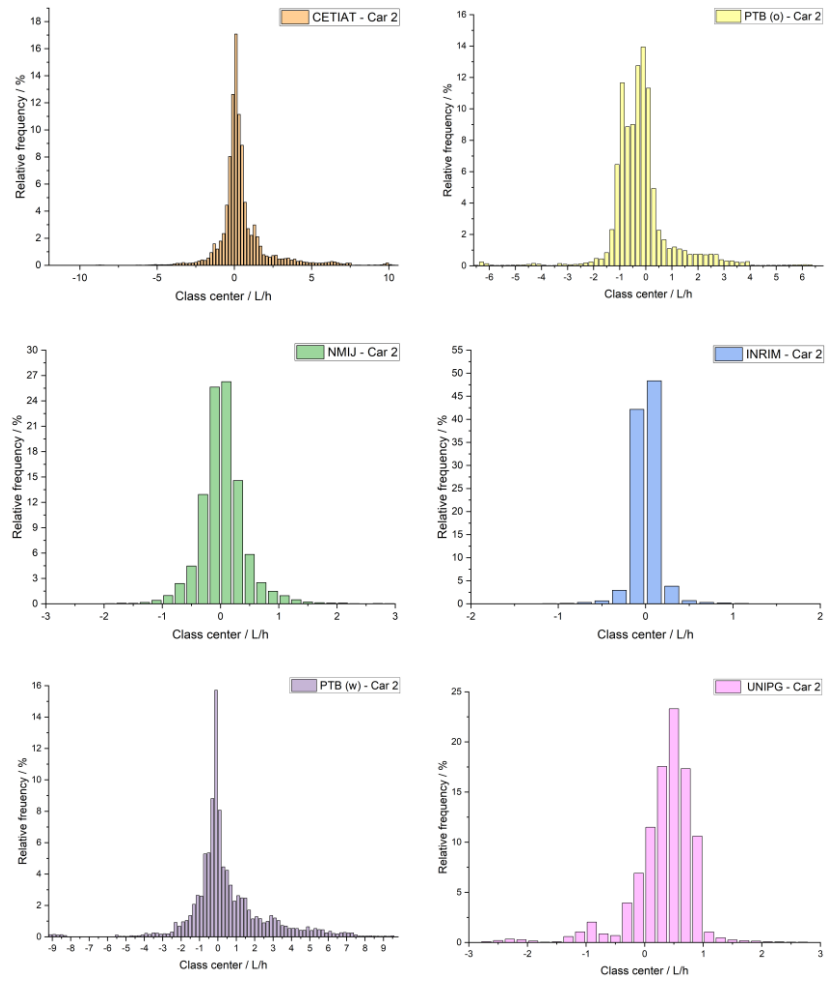

Figure 28: Distribution of residuals passenger car profile 2.

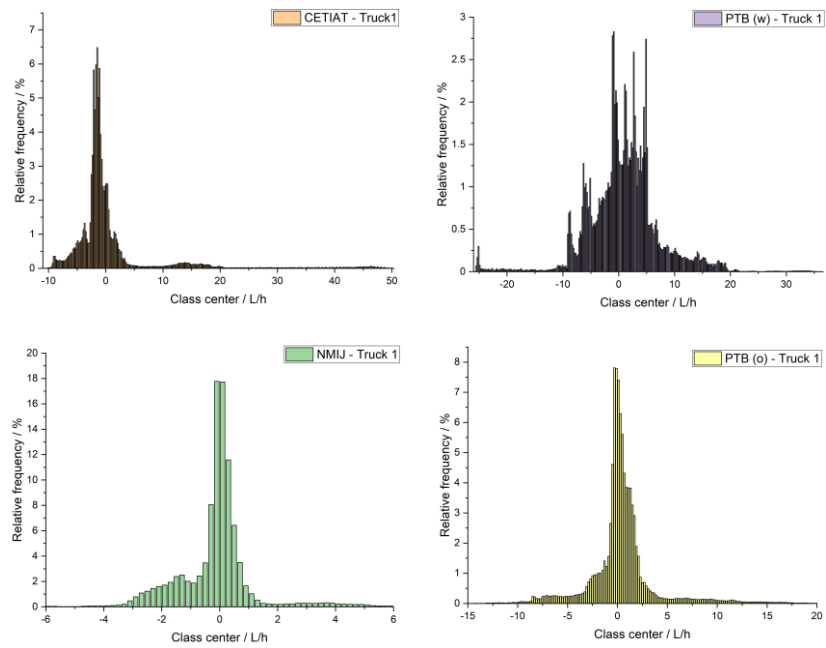

Figure 29: Distribution of residuals truck profile 1.

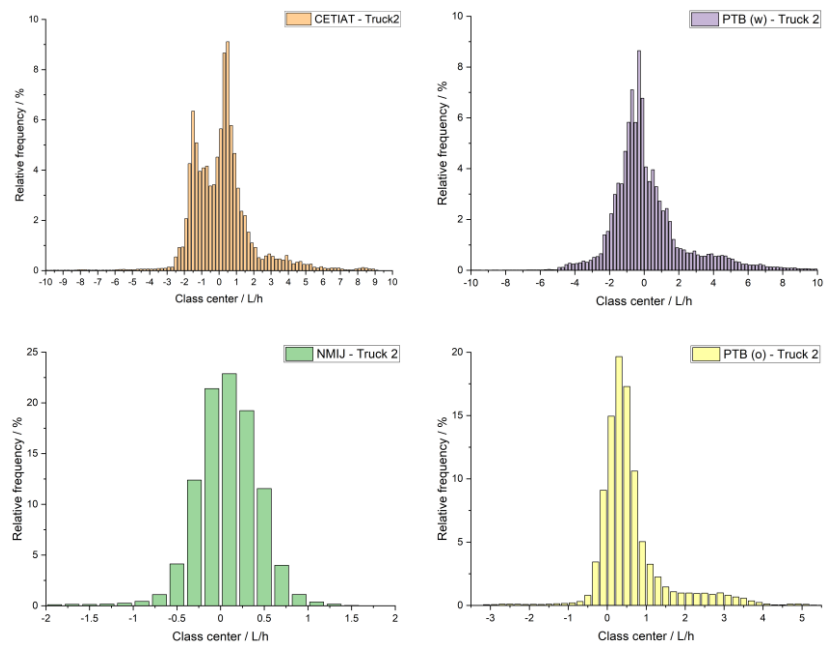

Figure 30: Distribution of residuals truck profile 2.

7 References

- [1] <https://www.ptb.de/empir2021/safest/the-project/>
- [2] Büker, O., Stolt, K., Kroner, C., Warnecke, H., Postrioti, L., Piano, O., Hagemann, G., Werner, M., 2023. **Characterisation of a Coriolis flow meter for fuel consumption measurements in realistic drive cycle tests.**, 2023, Flow. Meas. Instr., vol. 93, doi.org/10.1016/j.flowmeasinst.2023.102424
- [3] D1 [Realization of a test bench capable to generate and measure dynamic flow profiles.pdf](#)
- [4] Frahm, E., Borchling, A., Mills, C., 2024. **The use of Coriolis meter as transfer standards in the field of fluid flow.**, 2024, XXIV IMEKO World Congress "Think Metrology", Hamburg, Germany
- [5] Yoshida T., Furuichi N., **Development of controllable volumetric prover for evaluating responsiveness of flowmeter under controlled-transient flows.** 2023, Measurement, vol. 208, <https://doi.org/10.1016/j.measurement.2023.112456>
- [6] <https://www.ptb.de/empir2018/metrowamet/the-project/>
- [7] Schumann, D., Kroner, C., Mickan, B., Tränckner, J., **Intermittierende Durchflusserzeugung unter Einsatz von Kavitationsdüsen.**, 2019, Technisches Messen, 87(1), 55-65, doi.org/10.1515/teme-2019-0087
- [8] Borchling, A., Franke, C., Kroner, C., Warnecke, H., 2024. **Evaluation of influencing factors in the realisation of dynamic flow profiles with cavitation nozzles.**, 2024, XXIV IMEKO World Congress "Think Metrology", Hamburg, Germany



**Bundesministerium
für Wirtschaft
und Klimaschutz**

Die Physikalisch-Technische Bundesanstalt, das nationale Metrologieinstitut, ist eine wissenschaftlich-technische Bundesoberbehörde im Geschäftsbereich des Bundesministeriums für Wirtschaft und Klimaschutz.



Physikalisch-Technische Bundesanstalt
Nationales Metrologieinstitut
ISNI: 0000 0001 2186 1887

Bundesallee 100
38116 Braunschweig

Presse- und Öffentlichkeitsarbeit

Telefon: (0531) 592-93 21
Fax: (0531) 592-30 08
E-Mail: presse@ptb.de
www.ptb.de