



ISTITUTO NAZIONALE DI RICERCA METROLOGICA Repository Istituzionale

Automatic DC voltage precision resistive divider with ratios between 10:1 and 107:1

This is the author's submitted version of the contribution published as:

Original

Automatic DC voltage precision resistive divider with ratios between 10:1 and 107:1 / Galliana, Flavio; Cerri, Roberto; Corona, Davide. - In: MEASUREMENT. - ISSN 0263-2241. - 183(2021), p. 109865.
[10.1016/j.measurement.2021.109865]

Availability:

This version is available at: 11696/70690 since: 2021-07-26T10:39:31Z

Publisher:

Elsevier

Published

DOI:10.1016/j.measurement.2021.109865

Terms of use:

Visibile a tutti

This article is made available under terms and conditions as specified in the corresponding bibliographic description in the repository

Publisher copyright

(Article begins on next page)

AUTOMATIC DC VOLTAGE PRECISION RESISTIVE DIVIDER WITH RATIOS BETWEEN 10:1 and 10⁷:1

Flavio Galliana¹, Roberto Cerri and Davide Corona³

^{1, 2, 3} National Institute of Metrological Research (INRIM)

Strada delle Cacce, 91, 10135 Turin, Italy.

E-mail: f.galliana@inrim.it

ABSTRACT

At INRIM an automatic DC Voltage resistive divider performing decade ratios from 10:1 to 10⁷:1 was built. It can be calibrated with a top-class calibrator and a precision multimeter calibrated in term of deviation from linearity. It is made up of 90 k Ω , 9 k Ω , 900 Ω , 90 Ω , 9 Ω , 0.9 Ω , 90 m Ω and 10 m Ω bulk metal foil resistors connected in series in four-terminal configuration. Particularities of the realization are the evaluation of the DMM input impedance during the divider calibration to correct the DMM readings to minimize the load error and a solution to reduce the relays emfs effect in addition to the polarity inversion. The divider calibration and use uncertainties span respectively from 6.1×10^{-7} to 5.9×10^{-4} and from 6.7×10^{-7} to 6.5×10^{-4} . The project is transferable to secondary electrical calibration laboratories in the framework of the INRIM knowledge transfer task.

Key words: DC Voltage divider; resistive divider; voltage ratio; measurement uncertainty; temperature dependence; short-term stability; use uncertainties multimeter; calibrator.

1. INTRODUCTION

Due to their high accuracy, voltage dividers are used for the realization of the DC voltage scale for which the Calibration Measurement Capabilities (CMCs) of National metrology institutes (NMIs) usually span from 1 mV up to few thousands V. No NMI or laboratory, although operating below 1mV, participated in key or supplementary comparisons to check possible CMCs below 1 mV. NMIs and high-level laboratories have used in the past manual type dividers [1, 2] as Ratio Standards for DC Voltage traceability and for calibration of high accuracy instruments as Digital Multi Meters (DMMs) and calibrators. At the National Institute of Metrological Research (INRIM) is also used an automated fixed-

ratio divider [3] for the same task. Guarded dividers were realized for precision DC voltage calibrations [4, 5] also at high voltages [6–11]. An interesting technique to determine the voltage ratios in self-calibrating dividers was developed at SPRING Singapore [12]. High precision binary Voltage dividers, based on the Cutkosky principle [13, 14], are already commercially available, but at high costs. Our realization, instead, consists in a not-commercial precision divider made up by easily available components and by instruments of which electrical calibration laboratories are normally equipped. Currently, nanotechnologies and medical or scientific applications need the use of ultra-low voltage meters and generators to be calibrated. Unfortunately, nanovoltmeters are often used without calibration only relying on their manufacturers' specifications. In the best NMIs, nanovoltmeters are calibrated vs. the Josephson effect (JVS) [15], an expensive and time-consuming procedure. NMIs and laboratories without JVS need alternative methods. In [16–20] interesting solutions to calibrate sources and meters, also at low voltages, with easily available standards, are proposed. The aim of the construction of the INRIM divider, as part of the INRIM technology transfer task, was just the realization of a standard to involve, after its characterization, in a setup for calibration of nanovoltmeters extending the INRIM DC Voltage CMCs to lower values than current ones. The main role of the divider is therefore not that of a mid or long-term standard, but of a transfer standard that has to be calibrated before its use in a setup for calibration of other instruments (nanovoltmeters). The automation of its calibration was just made to facilitate this task than in the past when technicians were obliged to calibrate manually the dividers before using them for other scopes. In addition, the divider project could be transferable to NMIs without JVS and to secondary laboratories due to its easily available components.

2. DIVIDER DESCRIPTION

The divider consists of seven sections. (Fig.1). It is made up by 90 k Ω , 9 k Ω , 900 Ω , 90 Ω , 9 Ω , 0.9 Ω , 90 m Ω and 10 m Ω precision metal-foil Vishay high stability resistors built on our request. These resistors are connected in series in four terminal configuration. Their resistance values were chosen as a compromise between the highest possible values to carry the desired current providing output accurately

measurable voltages, and the lowest possible resistance values to assimilate, as much possible, the divider (supplied by a DC Voltage) to an ideal Voltage generator.

The resistors were soldered on double width copper-plated tracks to comply with the kelvin connection technique. Golden tracks and micro millings made in critical points allow higher insulations between the tracks than with other methods as photoengraving or galvanic treatment. The welds were made with tin and specific flux for low emfs. Fig. 2 shows the divider electrical scheme with the relays to connect the resistors to the calibrator and to the DMM for the divider calibration. The divider can be automatically and quickly calibrated with a calibrator and a DMM in about one hour. The involved DMM takes advantage of its excellent linearity to improve the divider's calibration uncertainty.

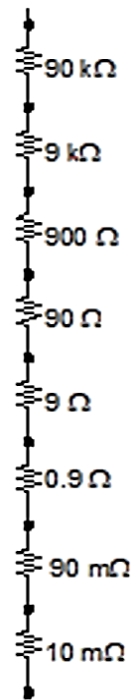

Fig. 1) Divider scheme

The bistable relays (TX-S2-L-4,5) have contact resistance of few $m\Omega$ as equipped with silver/gold contacts with thermo-electromotive forces (emfs) of about 40 nV. Being the relays of the bistable type, their activation is made by coupling the alternating coils sending them a single pulse. This minimize the noises due to the relays self-heating or to their excitation and maintenance voltage. Therefore, during the measurements, there is no voltage on their coils. The relays are monitored by the software to detect any anomalies. Fig. 3 shows instead the parts of the divider, whose resistors were inserted into the holes of a milled copper box to minimize electrical and thermal noises (Figs. 3 a, c). A 1 cm thick external drilled and milled aluminium case (Figs. 3c, d), further increases the thermal stability due to its mass. A thermal sensor monitors the resistors temperature. The connections of the relays with the resistors are very short to reduce parasitic resistances.

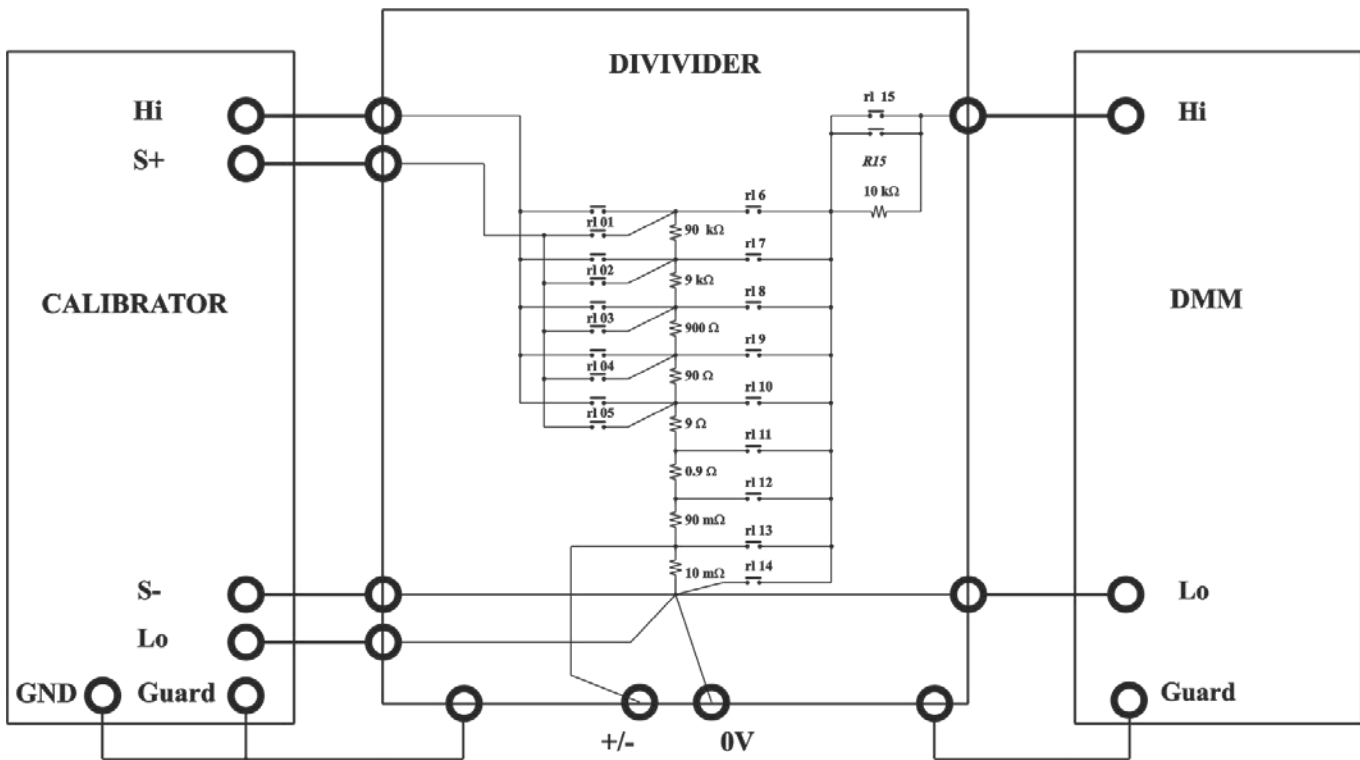

Fig. 2. Divider electrical scheme with the relays to connect the resistors to the calibrator and to the DMM for the divider calibration



Fig. 3a.

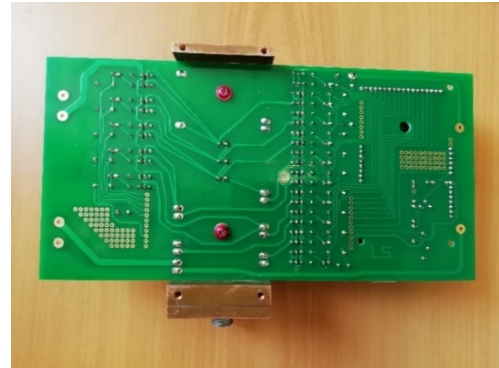

Fig. 3b.

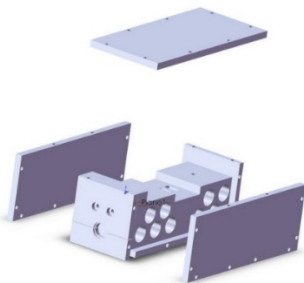

Fig. 3c.



Fig. 3d.

Fig. 3. Images of the divider parts a) Copper box, Arduino board, resistors and relays b) Printed circuit board bottom view c) Cross-section of the mechanical components d) External view with the 1 cm thick aluminium case. Fig. 3c does not show yet the holes for the connectors of the external case as these were made after this draw.

2.1 Voltage limits

The voltages applied to divider sections are 100 mV, 1 V and 10 V. The voltage limits to apply at the inputs of each section are:

- sections with input resistors of 90 k Ω and 9 k Ω : 10 V;
- sections with input resistors of 900 Ω and 90 Ω : 1 V;
- sections with input resistors 9 Ω , 0.9 Ω and 90 m Ω ¹: 100 mV.

These voltages are chosen to avoid to exceed the maximum current limits of the calibrator in DC Voltage [21]. High power resistors were chosen avoid heat dissipation. In fact, when the divider is calibrated, the applied power on the resistors is lower than their power limits.

2.2 Hardware - software interface

Inside the divider, an Arduino Mega2650 board acts as device driver so its management is the same of any instrument. The driver protocol defines which relay to activate/deactivate according to the command received on the serial port. The relays are switched through the digital outputs of the Mega 2650 board. A command for the temperature measure was added. Once received the command, the board performs a voltage reading (analog input) and transmits the read value through the serial port. The temperature value is obtained by implementing an algorithm in VB.Net code converting the read voltage. In Fig. 4, the architecture of the control program of the divider and of its calibration setup is shown.

¹ The input voltage is applied on the 9 Ω resistor to avoid over load on the calibrator see footnotes 2 and 3.

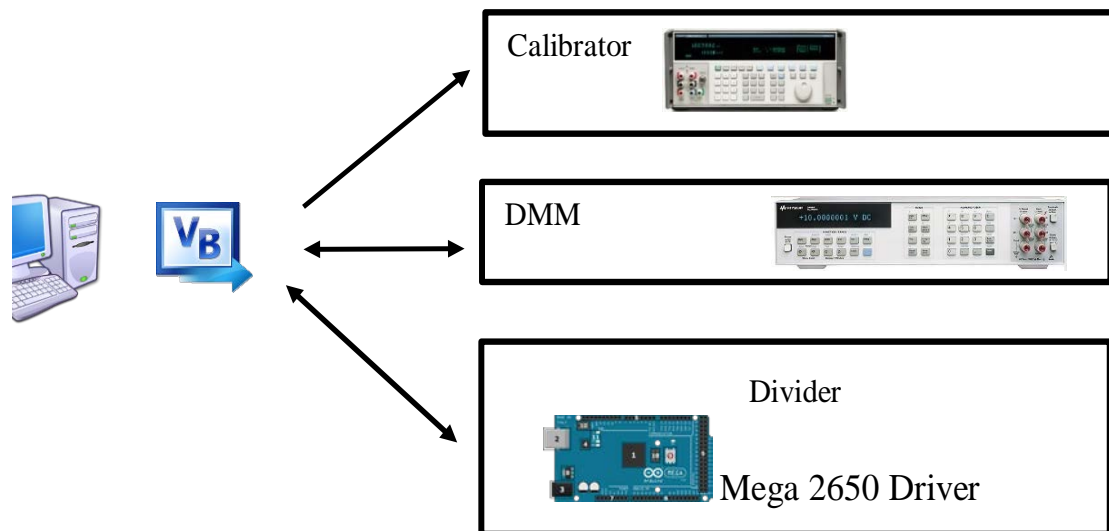

Fig. 4 Architecture of the control program of the divider and of its calibration setup.

The application in VB.net manages the three instruments during the measurement saving the acquired data on a file. The code consists in reading a two-dimension matrix on which the steps sequence to be performed is reported (by means of tokens); the setting, acquisition and stand-by routines of the three instruments correspond to each tokens. For the evaluation of the DMM impedance, a software procedure implementing the steps of the paragraph 5.1.1 was added.

The choice of Arduino was made for:

Robustness of the hardware. Arduino devices are very stable time and withstand well a lot of work cycles;

Versatility; the board has a grade availability of channels and on-board facilities for any additional option, both prototypal and not-prototypal;

Open-source code; the ease of use of the board allows inter-connection with any hardware environment;

Easy and affordable availability.

3. DIVIDER CALIBRATION

Interesting setups for calibration of DC Voltage dividers were developed at Justervesenet [22] and at NMIJ [23]. The calibration of the INRIM divider, allowing to update its ratios values, is

made by means of the setup of Fig. 2. involving the DMM and the calibrator [21] as high stability DC voltage generator and the DMM [24], calibrated in terms of its deviation from linearity [25, 26] (see paragraph 5). In Fig. 5, a photo of the measurement setup is shown.

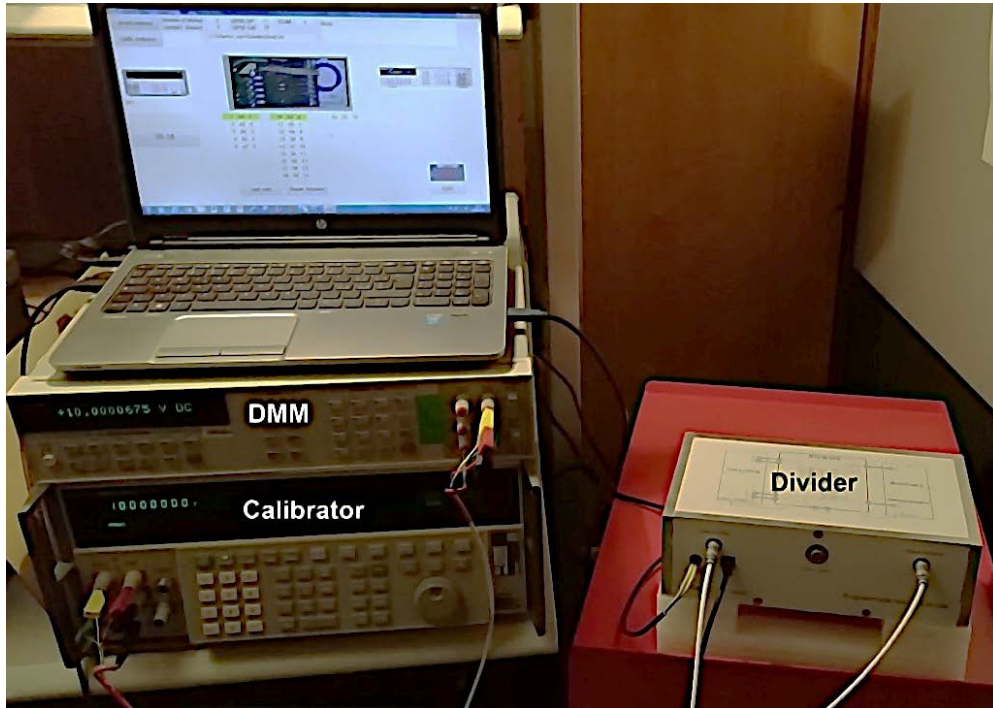

Fig. 5. Photo of the measurement setup to calibrate the INRIM divider.

The divider calibration is carried on by applying a DC Voltage by the calibrator to the input resistor of a divider section at a time. The DMM measures the voltage between this resistor and the ground. Then, leaving unchanged the supplying point and the voltage value, the DMM measures the voltage on the input resistor of the lower section without changing its range. By applying in cascade this strategy from the first to the last section, the ratio values from 10:1 to 10^7 :1 can be obtained.

For example, let's consider the calibration of the first divider section with 90 kΩ input resistor (100 kΩ to ground). A + 10 V voltage (V_H) is applied to this resistor and measured with the DMM on the 10 V range (L_{VH}).

Then, leaving unchanged the voltage application point, the DMM measures the output voltage V_L on the 9 kΩ resistor (10 kΩ to ground) $L_{VL} \cong 1$ V on the same range (Fig. 6).

Fig. 6. Voltages to be measured to calibrate the first divider section.

The same procedure is repeated at -10 V to minimize the emfs effects. The procedure includes, before each section change and before the polarities reversal, the evaluation of the zeroes to be added to the subsequent DMM readings. The calibration of the other sections is made in the same way only moving the voltage application point to the lower sections (one at a time). Consequently, the points where to measure V_H and V_L will move also to the resistors of the lower sections according to Table 1. The unknown ratios are given meaning the values at both polarities from:

$$R = \frac{L_{VH}}{L_{VL}} \quad (1)$$

Where $R \cong 10$ is the ratio, while L_{VH} and L_{VL} are the mean DMM readings in both polarities. In Table 1 the involved resistors, voltages and DMM ranges, are reported.

Table 1

Resistors, voltages and DMM ranges for the calibration of the INRIM divider.

Section	Overall ratio	Resistor to apply V_H	Resistor to measure V_L	L_{VH} (V)	L_{VL} (V)	DMM range (V)
1	10:1	90 kΩ	9 kΩ	10	1	10
2	100:1	9 kΩ	0.9 kΩ	10	1	10
3	1000:1	900 Ω	90 Ω	1	0.1	1
4	10 ⁴ :1	90 Ω	9 Ω	1	0.1	1
5	10 ⁵ :1	9 Ω	0.9 Ω	0.1	0.01	0.1
6	10 ⁶ :1	9 Ω ²	90 mΩ	0.01	10 ⁻³	0.1
7	10 ⁷ :1	9 Ω ³	10 mΩ	10 ⁻³	10 ⁻⁴	0.1

² V_H is applied on the 9 Ω resistor to avoid over load on the calibrator, but L_{VH} is measured on the 900 mΩ resistor.

³ V_H is applied on the 9 Ω resistor to avoid over load on the calibrator, but L_{VH} is measured on the 90 mΩ resistor.

4. DIVIDER CHARACTERIZATION

4.1 Temperature dependence

In Figs. 7a),...,g) the temperature dependence of the divider ratios is shown while in Table 2 the temperature coefficient (TCR) of the divider is reported for each ratio. The measurements were carried out in a high stability air-bath at (20.0, 21.5, 23.0, 24.5 and 26.0) °C.

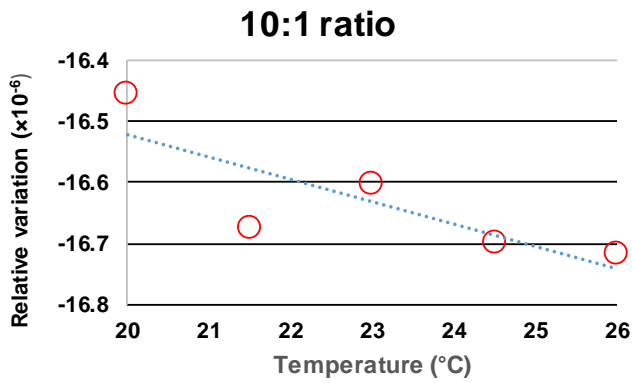

a)

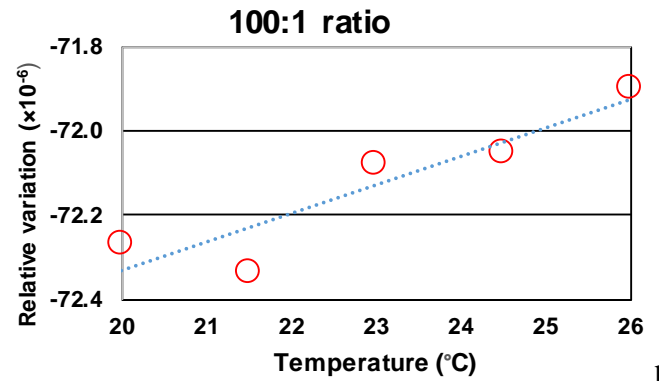

b)

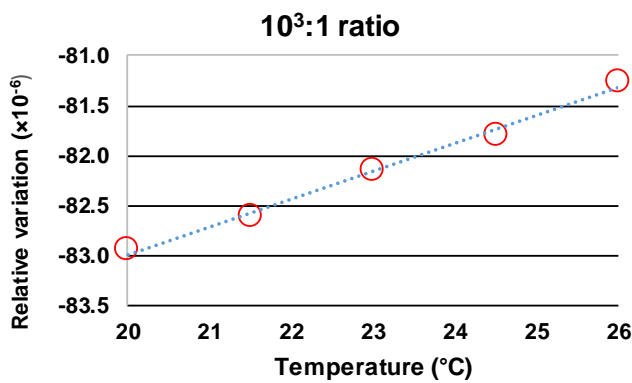

c)

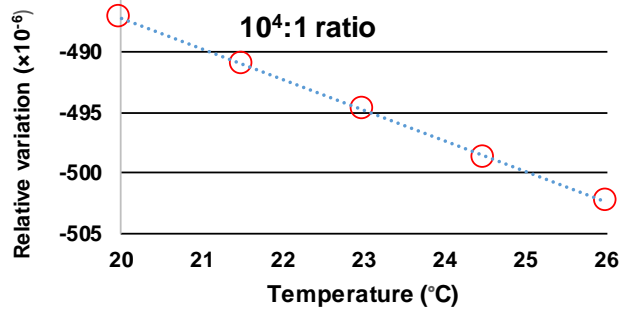

d)

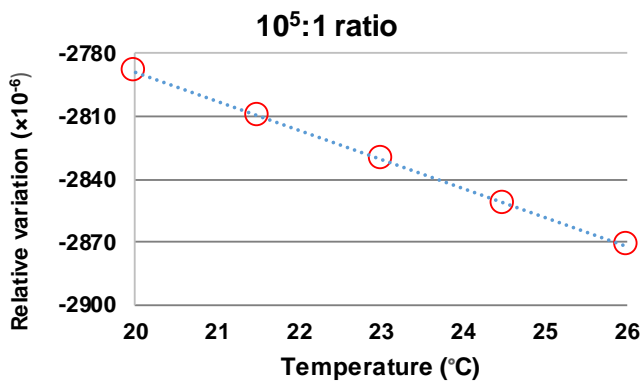

e)

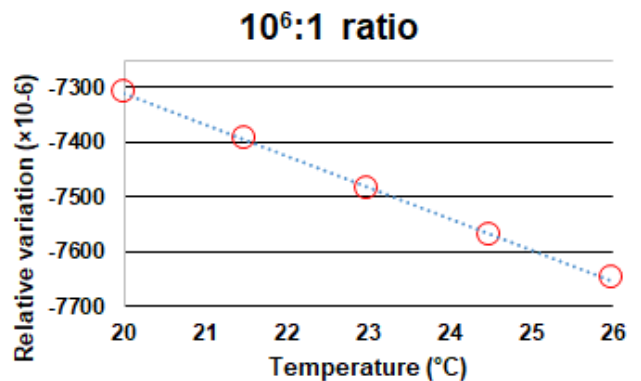

f)

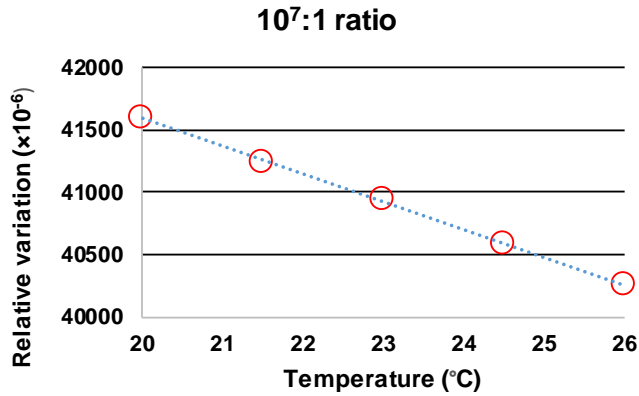

g)

Fig. 7 Temperature dependence of the divider in ratio a) 10:1, b) 100:1, c) 10³:1, d) 10⁴:1, e) 10⁵:1, f) 10⁶:1 g) 10⁷:1.

The obtained results show a substantial independence of the 10:1 and 100:1 ratios vs. temperature while in the other ratios the linear dependence vs. temperature is anyway satisfactory as it does not exceed the calibration uncertainties for the corresponding divider sections. In fact, the divider has to be used in laboratories where the temperature is normally maintained at $(23 \pm 1)^\circ\text{C}$. The dependence vs. temperature is presumably due to the not-zero temperature coefficient of the divider resistors, in particular those with lowest values, affecting higher ratios, justifying the increase of their TCR (Table 2). For the 10⁷:1 ratio, a temperature variation of $\pm 3^\circ\text{C}$ induces a ratio change of about $\pm 0.7 \times 10^{-3}$ vs. the value at 23 °C. This characterization allows to correct the ratios values if the divider is used in the whole evaluated temperature range. Ratio values are sometimes different from those of the following drift evaluation (in particular for higher ratios) as, for the temperature dependence evaluation, we used longer cables to connect the divider setup to the air-bath, causing presumably a systematic measurement error, not affecting anyway the temperature behaviour of the divider ratios.

Table 2.

TCR of the divider ratios.

Ratios	TCR ($\times 10^{-6}/^\circ\text{C}$)
10:1	-0.04
100:1	0.1
1000:1	0.3
10 ⁴ :1	-2.5
10 ⁵ :1	-13.9
10 ⁶ :1	-57.2

$$10^7:1 \quad | \quad -221.1$$

4.2 Short-term drift (5 days) of the divider ratios values

In Figs. 8a) g), the short-time dependence of the divider ratios is shown. In particular, the focus is on their 5-days drift.

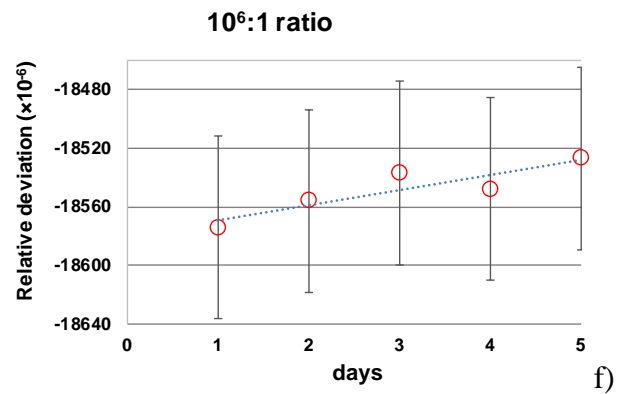
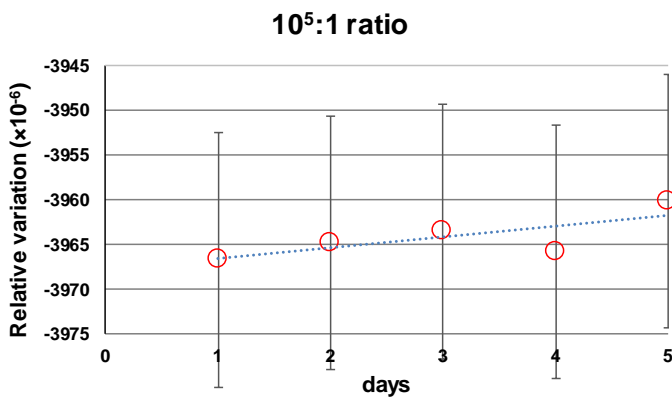
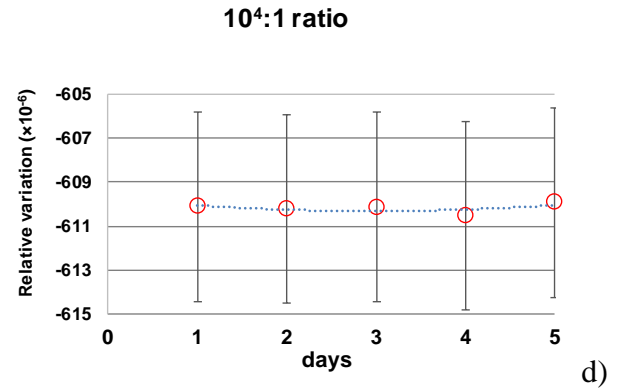
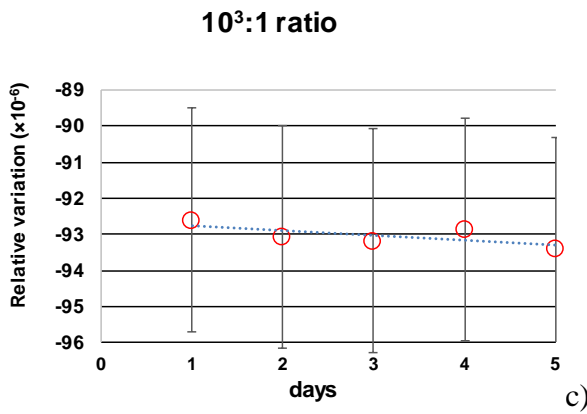
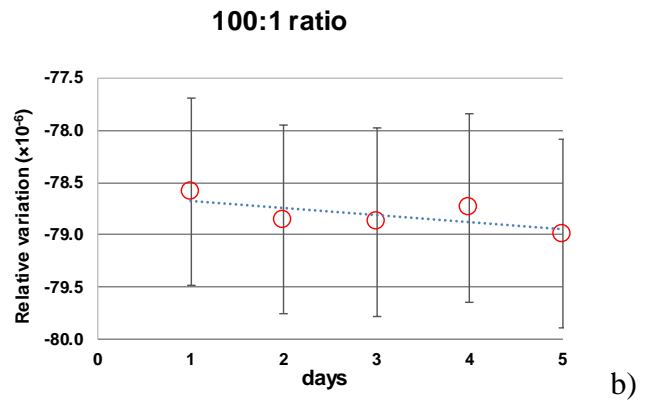
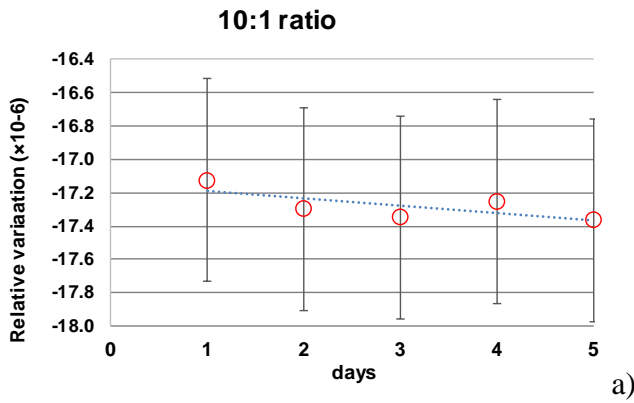

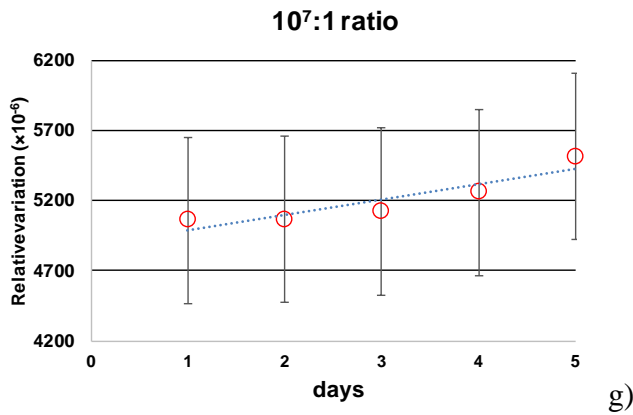

Fig. 8. Divider short-term (5 days) drift in ratio a) 10:1, b) 100:1, c) 10³:1, d) 10⁴:1, e) 10⁵:1, f) 10⁶:1 g) 10⁷:1. The uncertainty bars corresponds to the expanded calibration uncertainties.

The ratios from 10:1 to 10⁴:1 show a substantial invariability vs. time while in the last three ratios the drift is anyway satisfactory as it does not exceed the calibration uncertainties for the corresponding divider sections. The ratios drift is presumably due to the short term instability of the divider resistors, of the calibrator and of the DMM. The behaviour of the ratios vs. time allows to correct their values in the first days after calibration. The evaluation of the short-time drift of the divider helps a laboratory to decide, according to its measurement procedures and uncertainties, if to repeat or not the divider calibration before using it for calibration of other instruments. For example, if a laboratory needs that the 10⁷:1 ratio variation with respect to its calibrated value is less than 0.3×10^{-3} , it can use the divider without re-calibration within four days from its calibration, otherwise the divider has to be recalibrated. Although the role of the divider is not that of a mid, long-term standard, but of a transfer standard that has to be calibrated before its use for calibration of other instruments, in Figs. 9a)... g), the five days' stability test, repeated from May to September, is shown. The measurements were made in a normal laboratory at 23 ± 0.5 °C, so not all of them were satisfactory or possible, in particular those in July, when humidity control problems occurred in our laboratory. Measurements of the 10⁷:1 ratio are reported only for two months.

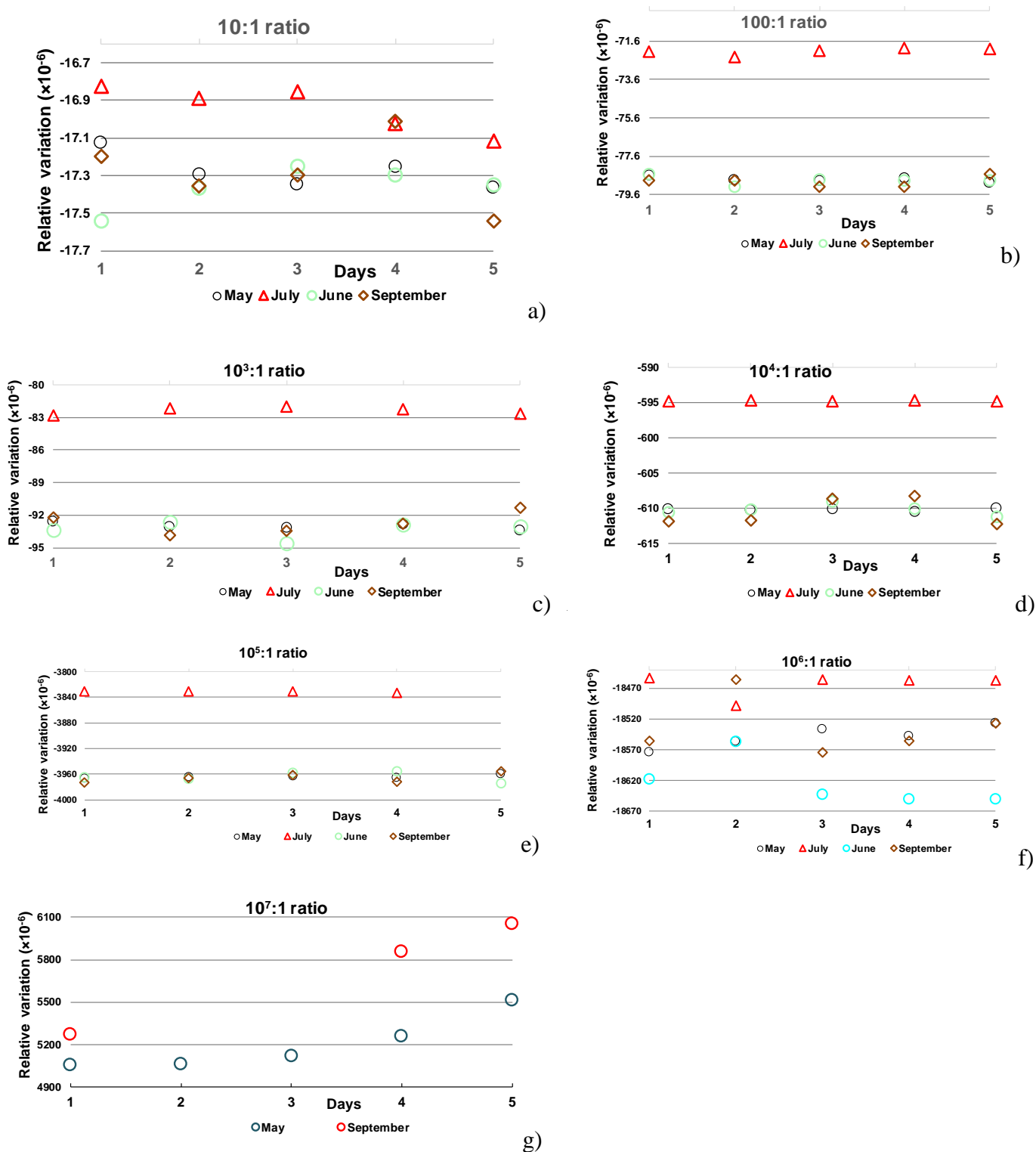

Fig. 9. Divider short term vs. mid-term drift in ratio a) 10:1, b) 100:1, c) 10³:1, d) 10⁴:1, e) 10⁵:1, f) 10⁶:1 g) 10⁷:1.

5. DMM CHARACTERIZATION

Important condition for the divider calibration is the use of a DMM that ensures the suitable precision.

The verification of the DMM linearity and the fast calibration process allow to take into account the

uncertainties of the DMM calibration in terms of deviation from linearity and the DMM transfer Accuracy/linearity specifications for the other measurement points, being both much smaller than the DMM Accuracy specifications. The DMM used in the divider calibration in fact was previously calibrated and characterized by direct comparison vs. JVS in the 10 V, 1 V and 100 mV ranges. **The DMM calibration in terms of deviation from linearity assures that the DMM measurements made in a specific range comply with the linearity specifications of the manufacturer. These specifications are normally two-orders better than the accuracy ones. In addition, to check the DMM vs the JVS allows to declare further better uncertainties as the comparison DMM-JVS has a lower uncertainty than the linearity specifications. *Sine qua non conditio* of this criterion is that the measurement of the voltages V_H and V_L is carried out in the same DMM range to take advantage of the DMM linearity within the range. Once made this verification with satisfactory result, the DMM measurements can be accepted without correction. This is a calibration in *linearity* (i.e. using the DMM linearity feature). The measurements are therefore affected only by the very small uncertainty of the DMM calibration vs. the JVS and by the measurements noise (repeatability). Without the DMM calibration in terms of deviation from linearity, the measurements should be made in two different ranges, as 10 V and 1 V ranges respectively for V_H and V_L of the first section. This is a calibration in *gain* (i.e. using the DMM gain feature) whose uncertainty corresponds to the DMM accuracy specifications (besides the measurements noise) leading to an overall larger uncertainty. The DMM deviation from linearity in these ranges is shown in Figs. 10-12 where the two colored bullets represent respectively the linear and polynomial fits of the measurement results. The deviation from linearity feature does not change over time unless the DMM undergoes damages or repairs.**

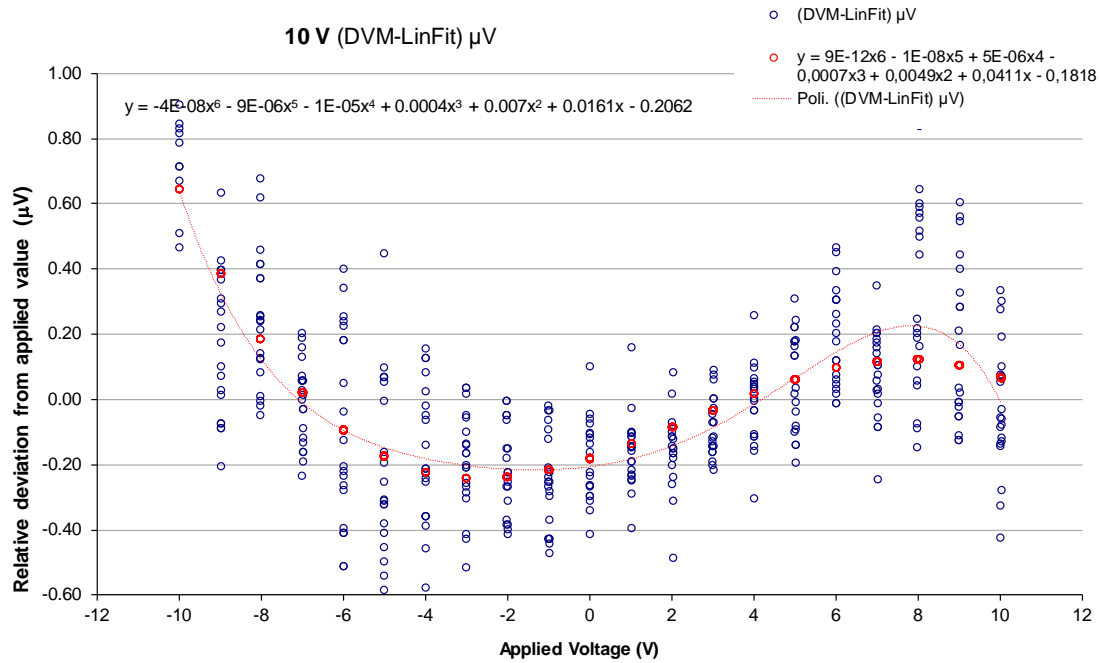

Fig. 10. Deviation from linearity of the selected DMM in the 10 V range. The two coloured bullets represent respectively the linear and polynomial fits of the measurement results.

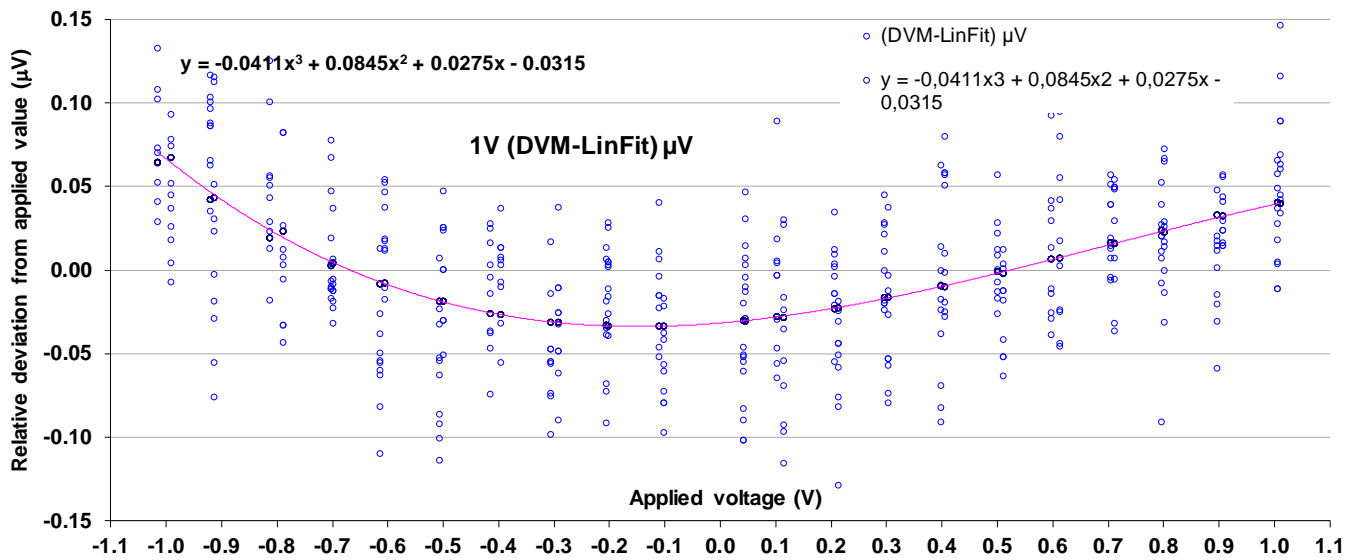

Fig. 11. Deviation from linearity of the selected DMM in the 1 V range. The two coloured bullets represent respectively the linear and polynomial fits of the measurement results.

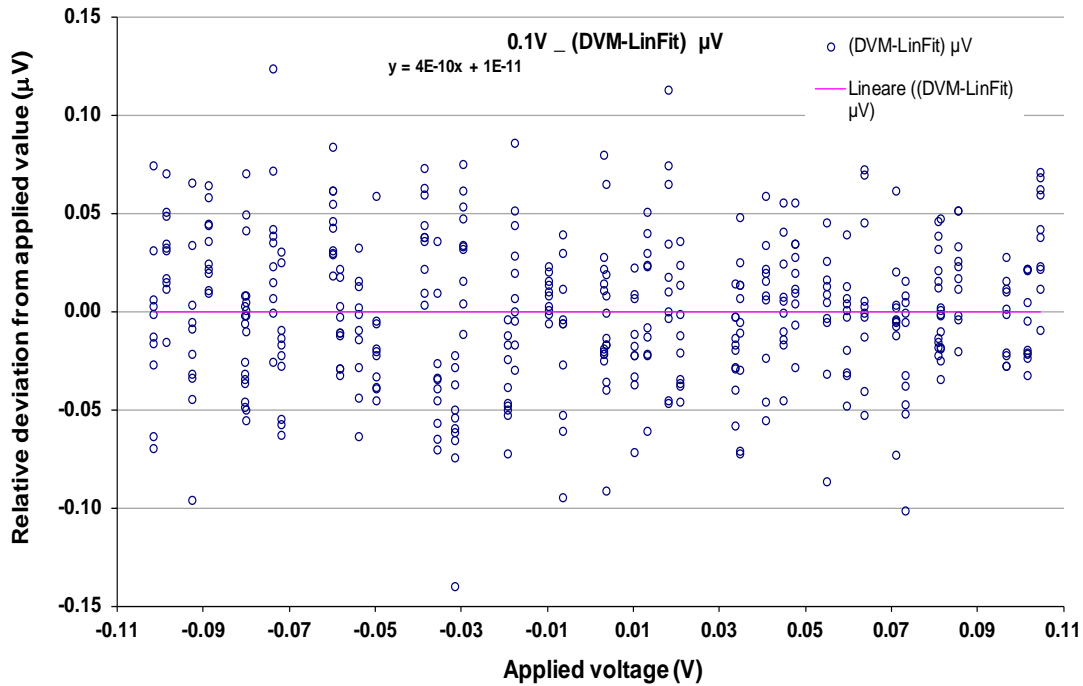

Fig. 12 Deviation from linearity of the selected DMM in the 0.1 V range. The two coloured bullets represent respectively the linear and polynomial fits of the measurement results.

Considering the results of the DMM calibration and the satisfactory repeatability, the DMM readings can be acceptable without correction for their deviation from linearity when the DMM is used to calibrate the divider. Nevertheless, an uncertainty component due to the DMM calibration in terms of deviation from linearity, has been added in the uncertainties budget.

5.1 Solutions to improve the measurement accuracy

The measurement process of the calibration of the divider allows also to evaluate the DMM input impedance to correct the DMM readings to minimize the DMM load effect. This evaluation is useful in particular for the calibration of the sections with higher output resistances, but it can be made for each section. A 10 k Ω resistance R_{15} , normally shorted, was added in the circuit (Fig. 2). When R_{15} is open it is in series with the DMM impedance forming a voltage divider (Fig. 12). Applying the procedure described in next sub-paragraph 5.1.1, it is possible to estimate the value of the current drained by the DMM and therefore its input impedance. This value allows to correct the DMM readings. To reduce the effect of the emfs of the relays contact resistances, an additional relay ($r/14$) was inserted at the bottom of the resistors chain to short-circuit the DMM. This solution allows to

perform a DMM voltage zeroing before the calibration of each divider section. The voltages measured by the shorted DMM are algebraically added to the DMM measurements of each section. This is particularly important for the sections with the lowest output resistances. The obtained values for these measurements have been less than 50 nV. This solution further reduces the effect of the emfs in addition to the inversion of the measurement polarity.

5.1.1 Evaluation of the DMM input impedance and correction of the DMM readings

In Fig. 2 it is possible to see an auxiliary resistor R_{15} (10 k Ω) normally shorted by the relay no. 15. Let's consider a zoom of Fig. 2 around R_{15} in Fig. 13. The evaluation of the DMM impedance is made starting from the 1 V measure of the first section, on the 9 k Ω resistor⁴(10 k Ω to ground). If R_{15} is shorted $V_{in} \cong V_{out}$. (Fig. 12) while if R_{15} is enabled it is in series with the DMM forming an auxiliary voltage divider with the DMM input impedance.

Fig. 13. Auxiliary voltage divider in the INRIM divider to evaluate the DMM impedance.

From the circuit of Fig. 13, enabling R_{15} , the following relations are valid:

$$I = \frac{V_{in}}{R_{DMM} + R_{15}} \quad (2)$$

$$V_{out} = R_{DMM} \frac{V_{in}}{R_{DMM} + R_{15}} \quad (3)$$

⁴ The DMM impedance evaluation is not possible only when the DMM measures the voltage on the 90 k Ω resistor (100 k Ω to ground), as, in that case, all the divider resistance should be in parallel configuration with the calibrator output resistance $\cong 0$.

From which with easy steps it can be obtained:

$$R_{DMM} = R_{15} \frac{V_{out}}{V_{in} \left(1 - \frac{V_{out}}{V_{in}}\right)} \quad (4)$$

For example, the R_{DMM} evaluation before the calibration of the first section is made repeating five times the measurement below averaging the five values of R_{DMM} obtained according to (4).

Table 3.

Example of a DMM impedance measurement.

V_{out}	V_{in}	R_{15}	R_{DMM}	R_{DMM}
(V)	(V)	(k Ω)	(G Ω)	(G Ω)
0.9999911	0.9999916	10	19.9998	19.9998

In table 3 V_{in} and V_{out} are the voltage values read by the calibrated DMM while the calibrator is not calibrated acting as high stability DC Voltage generator. The traceability to the DC Voltage national standard is assured by the calibrated DMM. In table 3 R_{DMM} is evaluated with two alternative relations giving the same result. After the determination of R_{DMM} , R_{15} is shorted again. R_{DMM} is now in parallel with the output resistance of the divider section under measure. If the output resistance is 10 k Ω , this resistance in parallel with R_{DMM} becomes 9.9999934 k Ω , i.e. 6.6×10^{-7} lower than its actual value. The correction of the DMM readings at 10 V will be therefore the increase of voltage values read by the DMM of the same relative value.

6. MEASUREMENT UNCERTAINTIES

In Table 4, the standard uncertainties due to the temperature and drift effects on the divider are reported. The temperature components have been evaluated assuming the use of the divider at a temperature of (23 ± 0.1) °C. All these components have been obtained by means of a linear fit of the measured data. The evaluation of these parameters is useful as the divider itself could be used also as travelling standard for interlaboratory comparisons (ILCs) [27] among laboratories operating

in DC Voltage ratio measurements. The evaluation of the temperature dependence for example allows to correct the measurements on the divider of the participants to an ILC at a reference temperature.

Table 4.

Standard uncertainties of temperature (u_T) and drift at 5 days of the INRIM divider (u_{stab}).

Ratios	$u_T (\times 10^{-7})$	$u_{stab} (\times 10^{-6})$
10:1	0.02	0.1
100:1	0.0	0.1
1000:1	0.2	0.2
10^4 :1	1.5	0.2
10^5 :1	8.0	1.9
10^6 :1	33.0	13.8
10^7 :1	128	131.1

The uncertainty due to the drift effect has been obtained evaluating the difference from the maximum and the minimum relative deviation from the ratio nominal value among the 5 days. This difference has been considered as the 2a interval of a rectangular distribution [28]. This smaller uncertainty has been considered as calibrated ratios values can be corrected according to their 5 days-drift.

6.1 Calibration uncertainties

Let's consider the example in which a 10 V voltage is applied on the 90 k Ω input resistance. Table 5 shows the budget of the standard uncertainties, according to [28], for the calibration of the first divider section while Table 6 lists the standard calibration uncertainties of all sections. The uncertainty of the calibration of the DMM in terms of deviation from linearity is considered instead of its one-year accuracy specification.

Table 5.

INRIM divider first section calibration standard uncertainties.

Component	Type	$1 \delta (\times 10^{-8})$
L_{VH} measurement noise	A	0.7
L_{VL}^5 measurement noise	A	1.2
10 V linearity calibration	B	Negl.
1 V linearity calibration	B	19
Calibrator stability	B	23
Emfs at 10 V	B	0.2
Emfs at 1 V	B	0.2
Load error correction at 10 V	B	
Load error correction at 1 V	B	

⁵ This measurement is also performed on the DMM 10 V range.

Contact resistances error correction at 10 V	B	0.7 ⁶
Contact resistances_error correction at 1 V	B	5.8 ⁶
		0.04
		0.4
Ratio Square Sum (RSS)		31

Where:

L_{VH} measurement and L_{VL} measurement noises are respectively the standard deviation of the mean of the DMM measurements at 10 V and at 1 V;

10 V linearity and 1 V linearity calibrations are respectively the uncertainties of the DMM calibration in terms of deviation from nominal value;

Calibrator stability is the short-time stability of the calibrator applying 10 V;

Emfs at 10 V, Emfs at 1 V are the uncertainties due to the emfs when the DMM measures respectively 10 V or 1 V;

Load error at 10 V and Load error corrections at 1 V are respectively the uncertainties of the corrected DMM measurements at 10 V and at 1 V for load effect;

Analogously, Contact resistances error at 10 V, Contact resistances error corrections at 1 V are respectively the uncertainties of the corrected DMM measurements at 10 V and at 1 V due to the emfs of the relays contact resistances.

Table 6.

INRIM divider calibration uncertainties of each section and of the overall ratios.

Section	$u_{sect} (\times 10^{-6})$	Overall ratios	$u (\times 10^{-6})$	$U (\times 10^{-6})$
1	0.31	10:1	0.31	0.61
2	0.31	100:1	0.43	0.9
3	1.5	1000:1	1.5	3.1
4	1.5	10 ⁴ :1	2.1	4.3
5	6.8	10 ⁵ :1	7.1	14.2
6	30	10 ⁶ :1	31.2	62.4
7	295.4	10 ⁷ :1	297.1	594.2

The uncertainties of the overall ratios have been evaluated taking into account a partial correlation ($r = 1.6 \times 10^{-4}$ for the first two sections) among the ratios measurement. r was calculated according to [29].

⁶ This component was evaluated considering the input impedance of the involved DMM selected among the available DMMs [24] as it resulted the one with the highest impedance ($\cong 8.6 \times 10^{11} \Omega$).

6.2 Use uncertainties

The use uncertainties of the divider (Table 7) are those to take into account when it is used in a measurement system for the calibration of other instruments [30]. The use uncertainties are usually larger than the calibration ones as the divider could be used at a slightly different temperature with which it was calibrated and could be used not immediately after its calibration. The use uncertainties are therefore obtained as RSS of the uncertainties due to its calibration, temperature effect and short-term drift [28].

Table 7.

Use uncertainties of each section and of the overall ratios of the INRIM divider.

Overall ratios	$u_{cal} (\times 10^{-6})$	$u_T (\times 10^{-6})$	$u_{stab} (\times 10^{-6})$	$u_{use} (\times 10^{-6})$	$U_{use} (\times 10^{-6})$
10:1	0.31	0.002	0.1	0.34	0.67
100:1	0.43	0.00	0.1	0.45	0.9
1000:1	1.5	0.02	0.2	1.56	3.1
10^4 :1	2.1	0.1	0.2	2.15	4.3
10^5 :1	7.1	0.8	1.9	14.4	28.8
10^6 :1	31.2	3.3	13.8	64	128
10^7 :1	297	12.8	131	325	650

Analyzing the accuracy specifications of two high-performance commercially available nanovoltmeters, the divider use uncertainties are suitable to involve it in a measurement setup for calibration of nanovoltmeters from 1 μ V to 10 V. In fact, the specifications of these nanovoltmeters, typically their one-year accuracy specifications, are larger than the use uncertainties of the INRIM divider. Therefore, it is suitable to be involved in a future setup for calibration of these instruments, as the uncertainty of the standard must always be smaller than that of the device under calibration.

Conclusion

From the obtained results, the performance of the divider is satisfactory considering its short-term stability, temperature dependence and use uncertainties. Calibrating the divider as described in the paper, it can be used for the calibration of nanovoltmeters from 1 μ V to 10 V. This because the divider must be used at the same voltages at which it is calibrated and characterized to take into account its

use uncertainties. Nevertheless, if the divider is characterized, for example, by applying 1 V to the first four sections, it is possible to calibrate nanovoltmeters from 100 nV to 1 V and so on even for lower input voltages. On the other hand, characterizing the divider at voltages lower than 10 V or at not decade values, an increase of its uncertainties is possible. Main dividers reported in the references, although very effective, do not provide as many ratios as our divider. To obtain division ratios down to mV levels, our divider could be compared with commercial self-calibrating binary dividers with similar uncertainties but available at high costs and with a totally different technology. At INRIM or in high level secondary laboratories the divider could be compared with the manually operating Fluke, 720 A Kelvin Varley voltage divider with a time consuming self-calibrating procedure vs. the quick automatic calibration process of our divider. In addition, the 720A has a too high output resistance to be employed for calibration of nanovoltmeters. Future aims of this work will be the evaluation of the transport effect as the divider can be used as travelling standard for ILCs. For this role, it could be transported by car, by plane or by express couriers. When a circuit for nanovoltmeters calibration involving the divider will be set up, a comparison with JVS or a with another validated method among those reported in references could be planned.

References

- [1] Fluke Corporation, 752 A reference divider Instruction Manual, Rev. 1, 1984.
- [2] Fluke Corporation, 720 A Kelvin Varley voltage divider instruction Manual, Rev. 2, 1974.
- [3] F.Galliana, P.P. Capra R. Cerri, M. Lanzillotti, Automated precision DC voltage fixed ratios divider, *Measurement* 122, 2018 pp. 291–296.
- [4] Y. Sakamoto, T. Endo, H. Shao, S. Matsuzawa, Automated dc voltage divider to calibrate voltages up to 1 kV, in: *Prec. El. Measur. Conf. CPEM*, (2000) 363–364.
- [5] Tadashi Endo, Y. Sakamoto, T. Sakuraba, Y. Murayama, H. Yoshida, A. Odawara, Automated voltage divider to calibrate a 10-V output of Zener voltage standard, *IEEE Trans. Instrum. Meas.* 40 (2) (1991) 333– 336.

- [6] H.Hirayama ; M. Kobayashi, K. Murakami, T. Kato, 10-kV high-Accuracy dc voltage divider, IEEE Trans. Instrum. Meas. 23 (4) (1974) 314– 317.
- [7] Yi Li, Miyuru K. Ediriweera, F. S. Emms, A. Lohrasby, Development of precision DC high-voltage dividers, IEEE Trans. Instrum. Meas. 60 (7) (2011) 2211–2216.
- [8] R.B.D. Knight; P. Martin, A high voltage divider having an uncertainty of 5 p.p.m. at 100 kV, IEEE Trans. Instrum. Meas. 54 (5) (2005) 568–570.
- [9] N. Dragounova, Precision high-voltage dc dividers and their calibration, IEEE Trans. Instrum. Meas. 42 (2) (1993) 1911–1915.
- [10] A.Mereva, Ö. Kalenderli, The construction of a dc high voltage precision divider, Journal of Electrostatics 67 (5) (2009) 741–745.
- [11] Yi Li, M. K. Ediriweera, F. S. Emms, A. Lohrasby, Development of Precision DC High-Voltage Dividers, IEEE Trans. Instrum. Meas. 60 (7) (2011) 2211–2216.
- [12] Ling Xiang Liu, Sze Wey Chua, Determination of DC Voltage Ratio of a Self-Calibrating DC Voltage Divider, IEEE Trans. Instrum. Meas., 54 (2) (2005) 571–575.
- [13] R. D. Cutkosky, A new switching technique for binary resistive dividers, IEEE Trans. Instrum. Meas., IM-27 (4) (1978) 421–422.
- [14] S. Hoi Tsao, A 25-Bit Reference Resistive Voltage Divider, IEEE Trans. Instrum. Meas., IM-36 (2), (1987) 285–290.
- [15] D. Georgakopoulos, I. Budovsky, S. Grady, and T. Hagen, Quantum Calibration System for Digital Voltmeters at Voltages from 10 nV to 1 kV, IEEE Trans. Instrum. Meas., 62 (6), (2013) 1581–1586.
- [16] D. E Murray, C. Laurie, T. B. Lawson, Building-up the DC Voltage Scale for Sources and Meters, Prec. El. Measur. Conf. CPEM (2014) 138–139.
- [17] D. Aviles, E. Navarrete, DC voltage traceability to microvolt and nanovolt levels, Prec. El. Measur. Conf. CPEM (2018) 1–2.

- [18] B.O. Andersson, Murray Early, G. Eklund, O. Gunnarsson and K.I-E. Rydler, The reference step method for DC voltage at 1 mV and 10 mV, *Prec. El. Measur. Conf. CPEM* (2014) 520–521.
- [19] B.-O. Andersson, G. Eklund and T. Bergsten, Calibration of Gain Ratios on nV-meters with the Reference Step Method, 31th. *Prec. El. Measur. Conf. CPEM* (2018) 138–139.
- [20] M. D. Early, M. Šíra, B.O. Andersson, L. A. Christian, O. Gunnarsson, A Simple Build-Up Method for the DC Voltage Scale of a Source, *IEEE Trans. Instrum. Meas.*, 62 (6), (2013) 1600–1606.
- [21] Fluke Corporation, 5700A/5720A Series II Multi-function calibrator service manual, Rev. 1, 3/02, June 1996.
- [22] H. Slinde and K. Lind, Precision Setup and Method for Calibrating a DC Voltage Divider's Ratios from 10 V to 1000 V, *IEEE Trans. Instrum. Meas.* 52 (2) (2003) 461–464.
- [23] Y. Sakamoto and H. Fujiki, DC Voltage Divider Calibration System at NMIJ, *IEEE Trans. Instrum. Meas.* 52 (2) (2003) 465–468.
- [24] Agilent Technologies, 3458A multimeter - User's Guide, revision: B.01, March 2001.
- [25] A. Sosso and R. Cerri, Calibration of multimeters as voltage ratio standards, in *Prec. Elec. Conf. CPEM 2000*, Sydney, NSW, (Australia), 2000, pp. 375–376.
- [26] J. I. Giem, Sub-ppm linearity testing of a DMM using a Josephson junction array, *IEEE Trans. Instrum. Meas.*, 40 (2), (1991) 329–332.
- [27] F. Galliana, Measurement comparisons: A tool to guarantee the reliability of measurement systems and of high-tech industry, *IEEE. Instrum. Meas. Magazine* vol. 22 (2) (2019) 62-66.
- [28] JCGM 100:2008 Evaluation of measurement data - Guide to the expression of uncertainty in measurement First edition.
- [29] F.Galliana, M. Lanzillotti, Accurate comparison between INRIM and a secondary calibration laboratory using a top-class multifunction electrical calibrator, *Measurement* 103 (2017) 353–360.

- [30] W. Bich, F. Pennechi, On the in-use uncertainty of an instrument, in: P. Ciarlini, M. G. Cox, E. Filipe, F. Pavese, D. Richter (Eds), *Adv. Math. Comput. Tools in Metrology*, World Scientific, (2004) 59–169.