



## ISTITUTO NAZIONALE DI RICERCA METROLOGICA Repository Istituzionale

Metrological characterization of MEMS accelerometers by LDV

*Original*

Metrological characterization of MEMS accelerometers by LDV / D'Emilia, G.; Gaspari, A.; Mazzoleni, F.; Natale, E.; Prato, A.; Schiavi, A.. - In: JOURNAL OF PHYSICS. CONFERENCE SERIES. - ISSN 1742-6588. - (2020).

*Availability:*

This version is available at: 11696/68022 since: 2021-03-05T10:21:46Z

*Publisher:*

Institute of Physics Publishing

*Published*

DOI:

*Terms of use:*

This article is made available under terms and conditions as specified in the corresponding bibliographic description in the repository

*Publisher copyright*

(Article begins on next page)

PAPER • OPEN ACCESS

## Metrological characterization of MEMS accelerometers by LDV

To cite this article: Giulio D'Emilia *et al* 2020 *J. Phys.: Conf. Ser.* **1589** 012011

View the [article online](#) for updates and enhancements.



**240th ECS Meeting** ORLANDO, FL

Orange County Convention Center Oct 10-14, 2021



Abstract submission due: April 9

**SUBMIT NOW**

# Metrological characterization of MEMS accelerometers by LDV

Giulio D'Emilia<sup>1</sup>, Antonella Gaspari<sup>1</sup>, Fabrizio Mazzoleni<sup>2</sup>, Emanuela Natale<sup>1</sup>,  
Andrea Prato<sup>2</sup>, Alessandro Schiavi<sup>2</sup>

<sup>1</sup>University of L'Aquila, Department of Industrial and Information Engineering and of Economics, L'Aquila, Italy

<sup>2</sup>INRiM – National Institute of Metrological Research, Division of Applied Metrology and Engineering, Torino, Italy

giulio.demia@univaq.it

**Abstract.** In this work two calibration methodologies, able to characterize the digital sensitivity of MEMS accelerometers, are presented and compared, to identify the contributions for the evaluation of the reproducibility in the low frequency range. The methodologies are different from the point of view of test bench, test procedure and data processing method. In particular, different vibration actuators are used, a linear slide and an electro-dynamic shaker, different sensors as a reference for the calibration, piezoelectric accelerometers and a Laser Doppler Vibrometer (LDV). A group of 5 accelerometers is tested for the purpose of developing the calibration techniques and evaluate a first reproducibility estimate. The experimental results provided by the two calibration procedures show significant differences. Some elements that could explain these differences have been identified, and will be further investigated in future work.

## 1. Introduction

Digital sensing systems, based on MEMS technology, are nowadays largely used in a wide range of advanced industrial, environmental, energy and medical applications [1-5], due to their low costs, low power consumption and to the possibility of integration in sensor networks.

It should be considered that MEMS accelerometers, in comparison to high-performance traditional transducers, are characterized by lower accuracy [6] and require proper calibration techniques, more flexible than traditional one and also suitable for field calibration, and less expensive, while guaranteeing, at the same time, traceability and accuracy [7-10].

One of the main aspects of interest concern the possibility of *on-line* calibration, e.g., without moving sensors from measuring position [11,12]. The possibility of assuming requirements and procedures of existing standards for accelerometer calibration, such as ISO 16063-21, should be compared with the above issue, beyond to be a very interesting topic for metrological research.

A possible way to contribute to this aim is individuating the main interfering quantities with respect to real configurations of sensors and evaluating their effects, in order to model their behavior and to quantify the reproducibility of their results. Reproducibility evaluation allows to realize a procedure able to support on line traceability of MEMS sensors at a possible low cost.



According to indication of standards (ISO/IEC Guide 98-3, ISO 17025), the budget of uncertainty could be a useful tool to integrate the different contributions of interfering quantities to the whole uncertainty in complex applications and taking them under control. A previous application by the authors demonstrated that this tool could be useful [13]; furthermore, bias effect could be analyzed by inter-laboratory comparison, which is a well-established procedure.

Aim of the work is to develop a metrological methodology able to characterize MEMS accelerometers, identifying the contributions useful for the evaluation of their reproducibility, in the low frequency range, below 10 Hz [15]. Most of the instructions of ISO 16063-21 will be used for calibration, but adapting the procedure to the specific requirements of digital MEMS sensors.

Repeatability and reproducibility will be evaluated, using calibration benches of different quality levels and different processing methods of the calibration data. In particular, different vibration actuators will be used, a linear slide and an electro-dynamic shaker, different sensors as a reference for the calibration, piezoelectric accelerometers and a Laser Doppler Vibrometer (LDV) and, finally, different data processing techniques for sensitivity evaluation. In particular, section 2 of the paper will present the main aspects concerning the test benches, the sensors used for calibration and the data acquisition and processing procedures; the comparison method will be also described. In Section 3 the main results will be presented and analyzed, in order to highlight the main aspects affecting the accuracy of calibration.

## 2. Materials and methods

The digital MEMS accelerometer investigated in this work is a commercial ultra-low-power digital MEMS accelerometer (STMicroelectronics, model LSM6DSR [16]), connected to an external IC-board (STMicroelectronics, model 32F769IDISCOVERY [17]).

The external microcontroller within the IC-board acquires the digital samples through a Serial Peripheral Interface (SPI) and provides the required power supply to the MEMS accelerometer. The acceleration information, acquired by the sensor, is converted into digital samples by a delta-sigma analog-to-digital converter ( $\Delta\Sigma$ -ADC). The PDM (Pulse Density Modulation) signal from the  $\Delta\Sigma$ -ADC is then converted through a low-pass filter and a decimation process into a standard 16-bit-signed PCM (Pulse Code Modulation) signal, with a sampling frequency of 6.2 kHz (figure 2).

The amplitude values range  $\pm 2^{16-1} = \pm 32768$  Decimal<sub>16-bit-signed</sub>, where the digit unit is a signed 16-bit sequence converted into a decimal number.

Sensitivity  $S$  of standard (analog) accelerometers is, generally, expressed in linear units,  $V/(m\ s^{-2})$ . In the same way, the sensitivity of the digital MEMS accelerometer is proposed to be expressed in linear units of Decimal<sub>16bit-signed</sub>/( $m\ s^{-2}$ ). [18]



**Figure 1.** The MEMS accelerometer connected to the IC board.

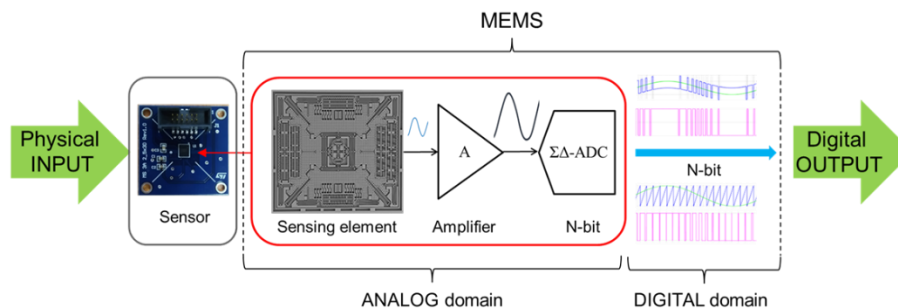

**Figure 2.** The analog domain of the inner components of the assembly and the digital domain of the IC-board for the output data managing.

A set of MEMS accelerometers has made available by the manufacturer for the characterization study. In this paper, a preliminary analysis has been carried out on 5 accelerometers for the purpose of developing and comparing the methodologies and evaluate a first reproducibility estimate.

Two different test benches have been considered, both based on Laser Doppler Vibrometer (LDV) as a reference:

- The INRiM test bench, consisting of a vertical single-axis vibrating table on which aluminum inclined planes are screwed.
- The UNIVAQ test bench, consisting of a vibrating table with a horizontal linear slide, on which an aluminum plane, perpendicular to the slide itself, is screwed.

### 2.1. INRiM calibration set-up and processing method

The INRiM calibration set-up, consisting of a single-axis vibrating table on which aluminum inclined planes are screwed, allows to generate a single vertical sinusoidal acceleration at a nearly-constant amplitude, acting as reference acceleration  $a_{ref}$  along the vertical axis of the system (parallel to  $g$ ). In this way, accelerations of proportional amplitudes released along the three axes, are simultaneously generated on the inclined surface plane. A detailed description of the set-up is available in [19].

The digital MEMS accelerometer is fixed to the inclined plane and located along the vertical axis of excitation. The vertical vibrating table is the PCB Precision Air Bearing Calibration Shaker.

The reference acceleration, along vertical axis  $a_{ref}$ , is measured by a single axis piezoelectric transducer:

- PCB model 080A199/482A23.

The reference piezoelectric transducer, located within the stroke of the vibrating table, is previously calibrated against INRiM primary standard [20], by using a Laser Doppler Vibrometer system:

- Polytec OFV-5000 Modular Vibrometer.

The IC board of the MEMS accelerometer to be calibrated, is connected to the computer by an USB interface. Data are acquired by an acquisition board *NI 4431* (sampling rate of 50 kHz) integrated in the PC and processed through LabVIEW<sup>®</sup> software to provide the RMS reference value in  $m\ s^{-2}$ . The digital MEMS output is acquired by the external microcontroller at a sampling rate of 1.660 kHz and saved as binary files. The digital MEMS accelerometer is fixed on the inclined plane by means of a double-sided adhesive tape.

The calibration of the accelerometer is performed simultaneously on the 3 axis. The geometrical principle of the proposed method and a configuration of the experimental calibration setup with the MEMS accelerometer is shown in figure 3.

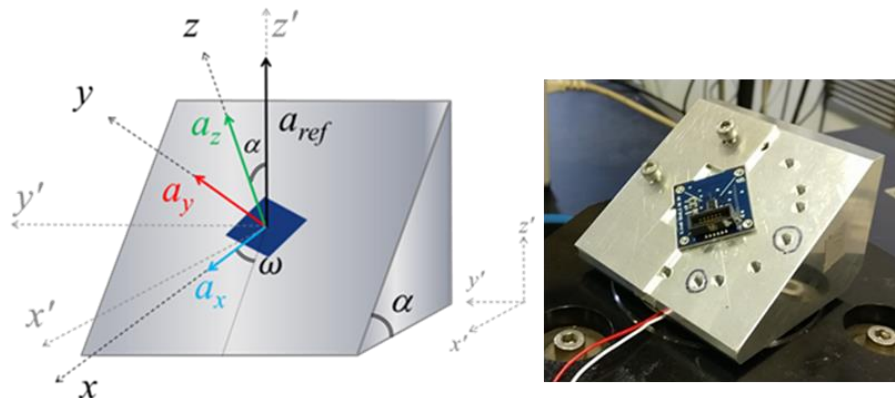

**Figure 3.** Inclined plane – 3-D scheme and measurement principle; calibration set-up: the MEMS fixed to the inclined plane on the vibrating table.

The binary files are processed with MATLAB<sup>®</sup> software. These files are then processed with MATLAB<sup>®</sup> software: the RMS digital value for each specific frequency  $f$ , expressed in  $\text{Decimal}_{16\text{-bit-signed}}$ , is obtained by applying a band-pass filter, centered at the frequency of interest with a fractional bandwidth of 10%, to the temporal digital signals and, subsequently, by computing the Root Mean Square, in order to remove the off-set due to gravity and the influence of background vibrations.

## 2.2. UNIVAQ calibration set-up and processing method

The UNIVAQ test bench consists of a vibrating table with a horizontal linear slide, the APS 113 ELECTRO-SEIS shaker. It is a long-stroke, electro-dynamic force generator specifically suitable for low-frequency vibration testing. The slide is moved according to a sinusoidal law.

Two different reference instruments have been used:

- a LDV, VS 100 by Ometron
- a piezoelectric accelerometer, PCB TLD356B18

The data acquisition system, used for the reference instruments, is the Compact RIO 9040 by National Instruments, and the module NI 9234 for both IEPE and non-IEPE sensors.

The board of the MEMS accelerometer to be calibrated, is connected to the computer by an USB interface.

The installation method provided by the manufacturer provides for gluing the sensor directly to the vibrating surface.

Each axis of the accelerometer is tested separately, positioning it in the direction of motion. Figure 4 shows the scheme of the experimental set-up.

In the Position 1 the MEMS is positioned on a plate installed on the slide, and the z-axis of the MEMS is in the direction of the motion; the reference accelerometer is positioned on the other face of the plate (figures 4.a and 5), and the laser beam of the LDV is pointed on it.

For the testing of the x and y axes, the MEMS is placed directly on the slide (Position 2), with the x-axis and the y-axis respectively oriented in the direction of the motion (figure 4.b).

For each axis of each MEMS accelerometer, repeated tests have been carried out. Measurements have been carried out at nearly-constant amplitude of  $2 \text{ ms}^{-2}$ , at the oscillation frequencies: 3, 6 and 10 Hz.

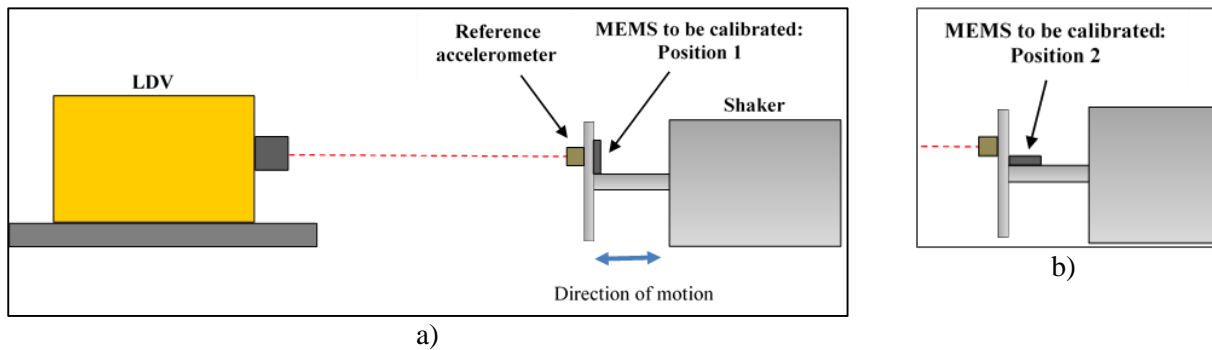

**Figure 4.** Scheme of the test bench, with the MEMS accelerometer in Position 1, for the testing of the z-axis. b) Position 2 of the MEMS accelerometer, for the testing of the x and the y axes.

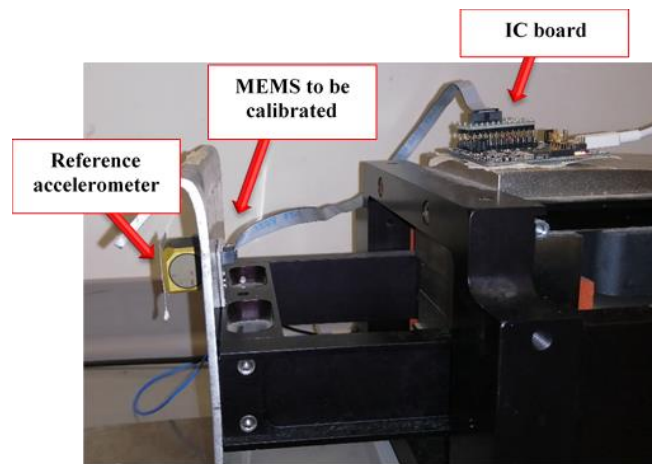

**Figure 5.** Picture of the accelerometers installation (MEMS in Position 1).

The data from sensors have been processed in Matlab environment.

Two different processing methods have been used and compared:

1. The first method (“FFT” method) is based on the FFT of the MEMS and the reference signals. The amplitudes of the spectrum in the range centered at the oscillation frequency and width  $\pm 10\%$  of it, have been added up. Then, the sensitivity is obtained by dividing the values thus calculated for MEMS and reference.
2. The second method (“Percentiles” method) is based on the calculation of the percentiles of the amplitude signals from both MEMS and reference sensors. Then, the sensitivity of the MEMS, for each axis, is calculated as the ratio of the mean of percentiles referred to MEMS and reference sensors in a specified range of percentiles; as a first attempt, the ranges 5 to 30 and 70 to 95 have been used. It has to be pointed out that the percentiles between 30 and 70 have been excluded, because the signal amplitude is close to zero and, therefore, characterized by a worse signal-to-noise ratio; percentiles near the peaks have also been excluded.

### 3. Results

#### 3.1. INRiM results

Calibration is carried out at 3 frequencies, namely 3 Hz, 6 Hz and 10 Hz, by comparison to a reference transducer (in analogy to ISO Standard 16063-21 [21]), previously calibrated by means of LDV



(according to ISO Standard 16063-11 [22]) and in four configurations, each one corresponding to a different combination of inclination ( $\alpha$ ) and rotation ( $\omega$ ) angles, summarized in Table 1.

**Table 1.** Calibration configurations

	inclination $\alpha / ^\circ$	rotation $\omega / ^\circ$
Conf. 1	0	270
Conf. 2	15	90
Conf. 3	75	0
Conf. 4	75	90

The reference acceleration  $a_{ref}$  is generated, as a mechanical dynamic excitation along a single-axis, at nearly constant amplitude of  $1 \text{ m s}^{-2}$ . From trigonometrical laws, according to the calibration set-up described in Section 2.1, the reference accelerations detected by the digital MEMS accelerometer, along its three sensitive axes, are:

$$a_x = |a_{ref} \sin(\alpha) \cos(\omega)| \quad (1)$$

$$a_y = |a_{ref} \sin(\alpha) \sin(\omega)| \quad (2)$$

$$a_z = |a_{ref} \cos(\alpha)| \quad (3)$$

where,  $\alpha$  is the inclination angle,  $\omega$  is the angle of rotation,  $a_{ref}$  is the Root Mean Square (RMS) reference acceleration along the vertical axis  $z'$  of the system, and  $a_x$ ,  $a_y$ ,  $a_z$  are the RMS reference accelerations spread along  $x$ -,  $y$ - and  $z$ -axis of the MEMS accelerometer.

Actually, the reference accelerations released along the three axes, in dynamic conditions, is corrected by taking into account the systematic effects caused by spurious oscillating components along the three axis ( $x'$ -,  $y'$ - and  $z'$ ) of the reference system at MEMS position, according to wave interference laws, as described in detail in [19].

Moreover, the acceleration component of equations (1-3), in  $\text{m s}^{-2}$ , is calculated in matrix form, as a linear combination of the 3-axis digital MEMS accelerometer outputs  $U_i$  in Decimal<sub>16bit-signed</sub>, as shown in following equations, where  $A_{ij}$  are the elements of the exploitation matrix  $\mathbf{A}$ :

$$[a_x \quad a_y \quad a_z] = [U_x \quad U_y \quad U_z] \begin{bmatrix} A_{xx} & A_{xy} & A_{xz} \\ A_{yx} & A_{yy} & A_{yz} \\ A_{zx} & A_{zy} & A_{zz} \end{bmatrix} \quad (4)$$

By calculating the inverse of matrix  $\mathbf{A}$ , the sensitivity matrix  $\mathbf{S}$  and its  $S_{ij}$  coefficients are obtained, in general matrix form, according to equation (5):

$$\mathbf{U} = \mathbf{a} \mathbf{A}^{-1} = \mathbf{a} \mathbf{S} \quad (5)$$

As a results, the values of “main” sensitivities  $S_{xx}$ ,  $S_{yy}$  and  $S_{zz}$ , located on the diagonal of the sensitivity matrix, are independent from the cross sensitivities, representing the interactions with the other axes.

Results are shown in Figure 6. For each frequency and for all tested MEMS, sensitivities along the three axes ( $S_x$ ,  $S_y$  and  $S_z$ ) are similar and in the most of cases compatible. Sensitivities at 3 Hz are systematically higher than 6 Hz and 10 Hz. Table 2 shows the reproducibility values among the five accelerometers tested, which are in the order of 3%.



**Table 2.** Reproducibility for each axis and each analysed frequency.

	<i>x</i> -axis	<i>y</i> -axis	<i>z</i> -axis
3 Hz	3,4%	3,5%	2,5%
6 Hz	3,1%	3,1%	3,0%
10 Hz	3,5%	3,3%	3,2%

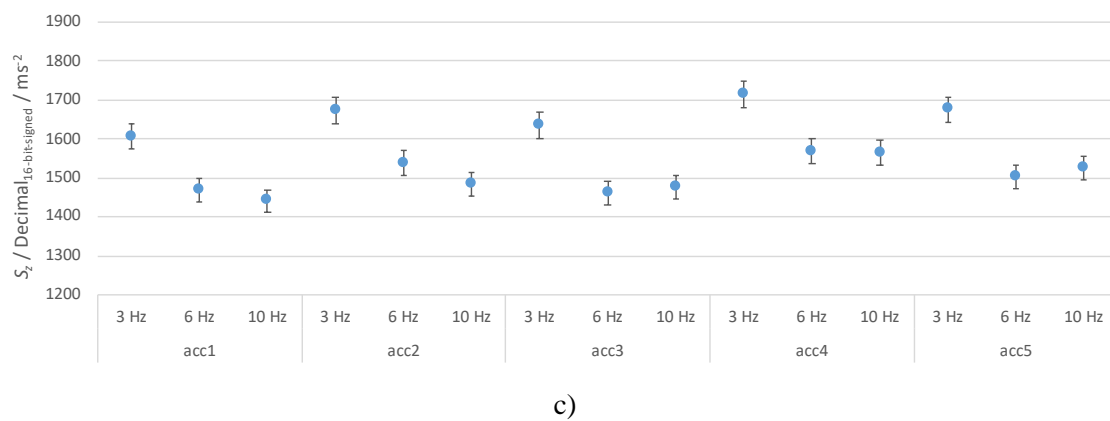
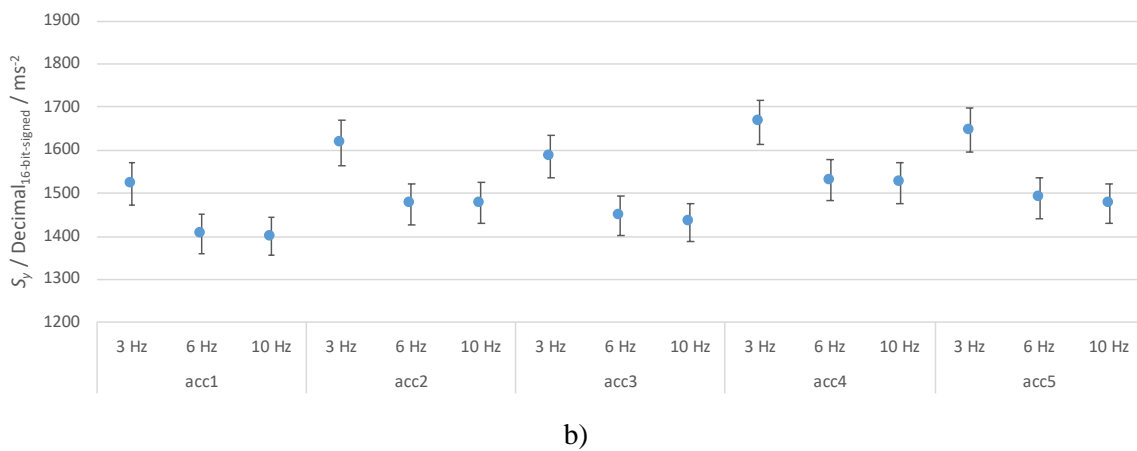
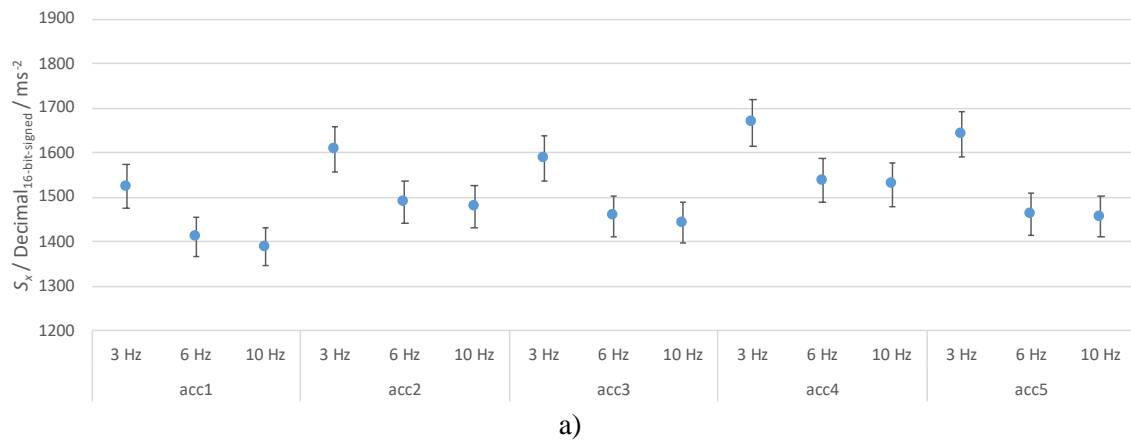

**Figure 6.** Comparison between sensitivities. Results for: a) the *x*-axis; b) the *y*-axis; c) the *z*-axis.

### 3.2. UNIVAQ results

This section summarizes the results obtained by testing the MEMS sensors on the UNIVAQ bench, using the two described analysis techniques ("FFT" and "Percentiles") and two reference instruments (LDV and piezoelectric accelerometer).

In particular, figures from 7 to 9, show, respectively, a comparison between:

1. the results obtained using the LDV and the reference accelerometer. Processing method: "FFT".
2. the results obtained using the LDV and the reference accelerometer. Processing method: "Percentiles".
3. the results obtained using the two different processing methods, "FFT" and "Percentiles".  
Reference instrument: LDV.

Error bars in graphs represent the uncertainty at the 95% confidence level.

The repeatability of results is less than  $2 \text{ Decimal}_{16\text{bit-signed}}/(\text{m s}^{-2})$  in all cases.

The first graph (figure 7) shows that the results obtained using laser and reference accelerometer are congruent, and no significant differences are observed when the "FFT" method is used.

Figure 8 shows that, using the "Percentiles" method, no differences are observed for the z-axis, while significant differences are found in correspondence of the x and y axes. It has to be pointed out that the x and y axes are tested installing the MEMS accelerometer in Position 2, unlike the z-axis, which is tested in Position 1.

Finally, figure 9 shows that the two processing methods considered are satisfactorily congruent (except for the acc1, at 3 Hz: this case will be deepened in the following), when the laser is used as a reference instrument.

In summary, it can be observed that the two methods give compatible results, provided that high order frequency components don't intervene. The "FFT" method, by isolating the frequency of interest, is insensitive to these effects, whatever the reference instrument used.

Table 3 shows the reproducibility values at a confidence level of 95%, calculated considering all the methods of data processing, all the reference instruments and all the accelerometers tested: for the x and y axes the reproducibility is poorer than for the z-axis, as expected, given the observations made above. In any case the reproducibility values are less than 4%.

It has to be pointed out that, if only the results of the "FFT" method are considered, the reproducibility of sensitivity is in the order of  $\pm 1\%$ .

These results highlight the importance of positioning in calibration, since, if the reference and the accelerometer to be tested are installed in different points, the introduction of different frequency components can, in some cases, affect the results of the analysis. This aspect is particularly important in the practical applications of on-line calibration. However, the "FFT" method has proven to be robust with respect to the presence of interfering frequencies.

**Table 3.** Reproducibility for each axis and each analysed frequency, using both "FFT" and "Percentiles" methods.

	x-axis	y-axis	z-axis
3 Hz	3.6%	2.6%	1.2%
6 Hz	2.8%	2.0%	0.96%
10 Hz	3.4%	2.4%	0.82%

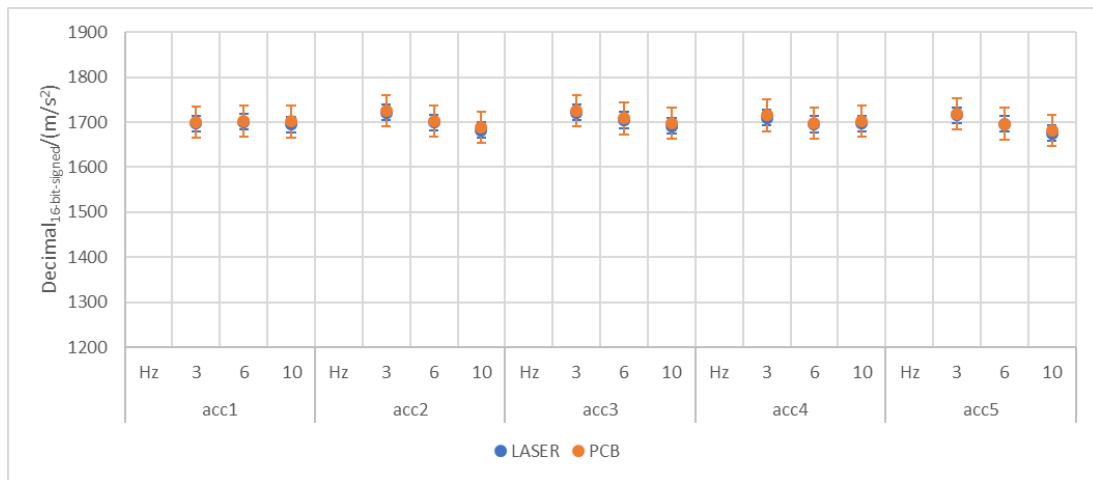

a)

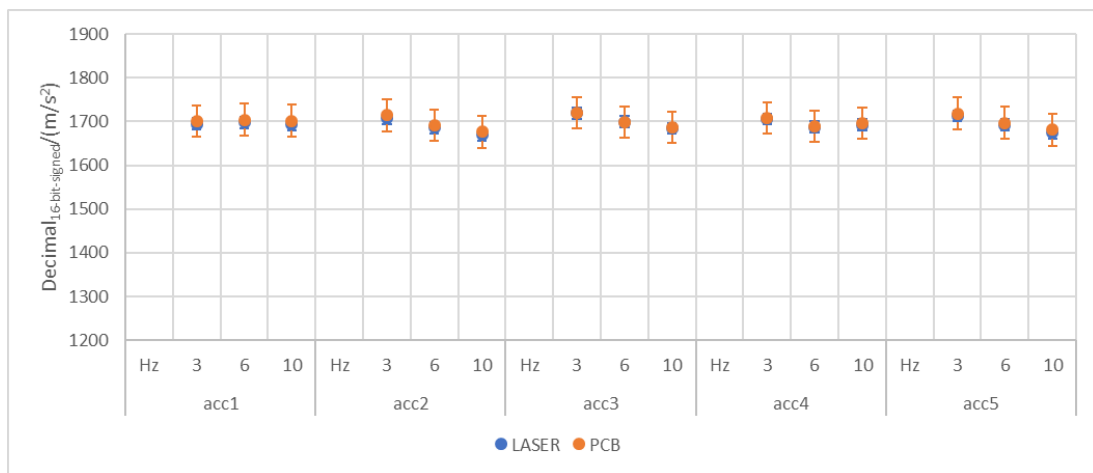

b)

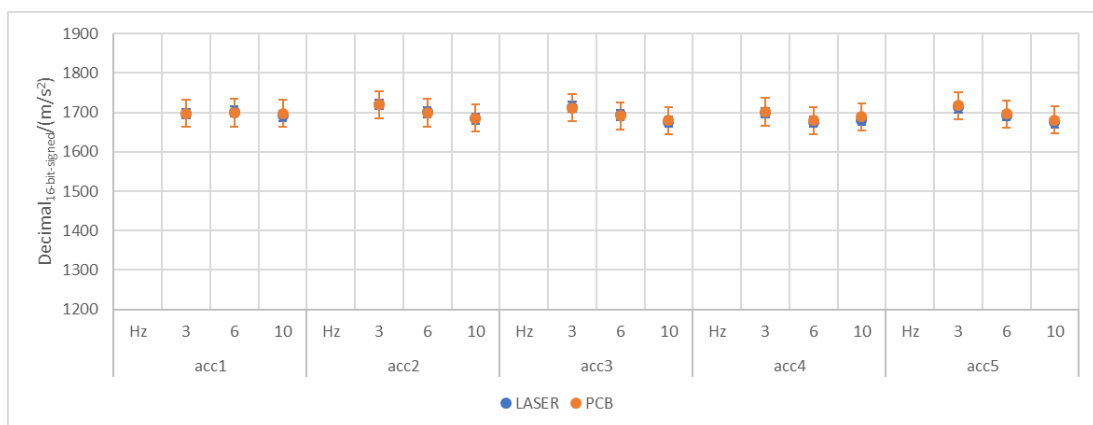

c)

**Figure 7.** Comparison between sensitivities, obtained using laser and piezoelectric accelerometer as a reference. Processing method: “FFT”. Results for: a) the x-axis; b) the y-axis; c) the z-axis.

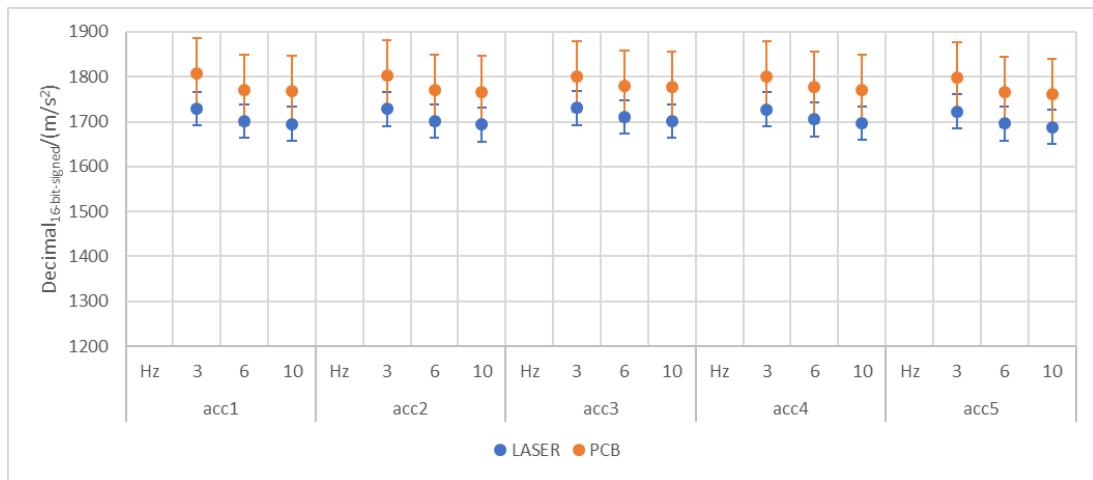

a)

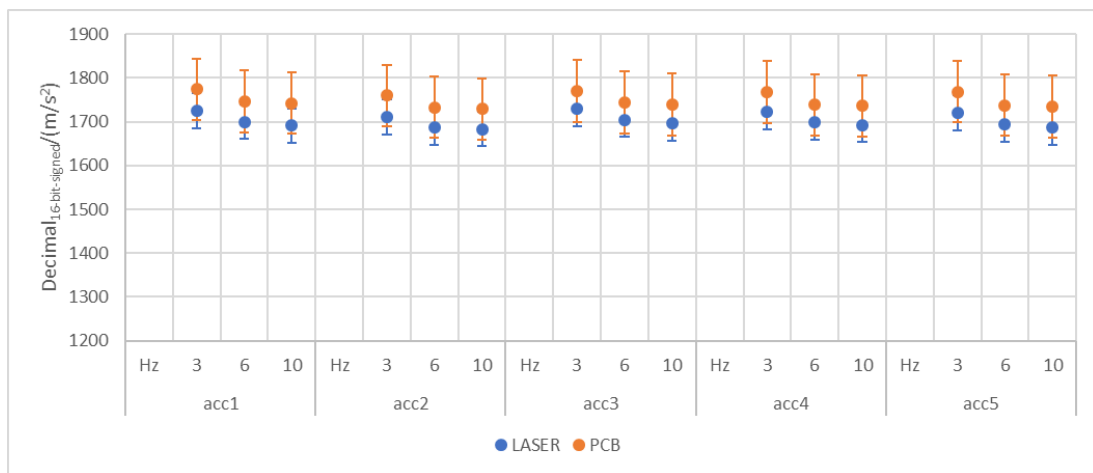

b)

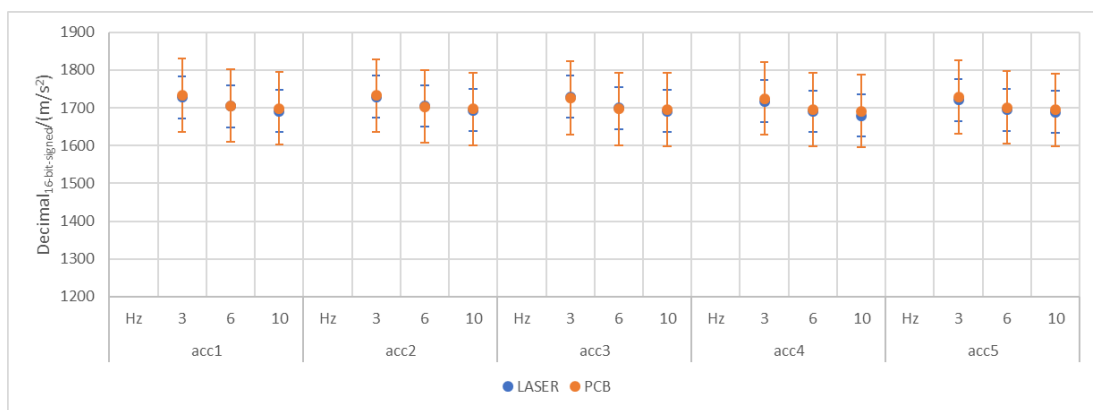

c)

**Figure 8.** Comparison between sensitivities, obtained using laser and piezoelectric accelerometer as a reference. Processing method: “Percentiles”. Results for: a) the x-axis; b) the y-axis; c) the z-axis.

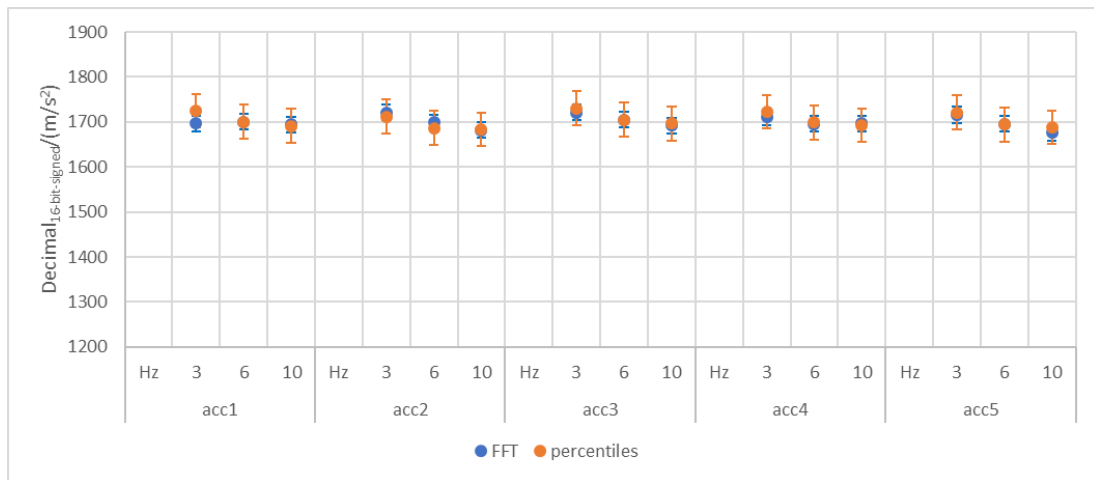

a)

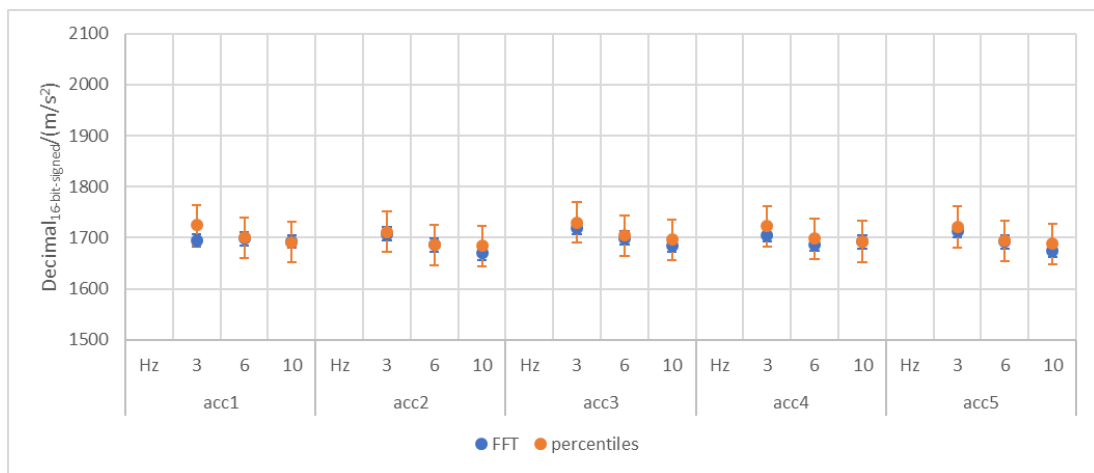

b)

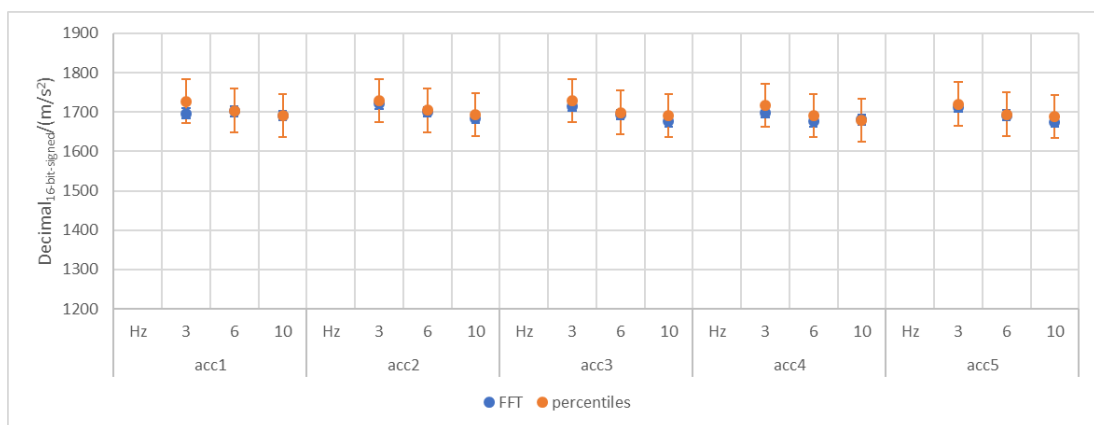

c)

**Figure 9.** Comparison between sensitivities, obtained using the “FFT” and “percentiles” processing methods. LDV is the reference instrument. Results for: a) the x-axis; b) the y-axis; c) the z-axis.

#### 4. Conclusions

In this work two methodologies, able to characterize the digital sensitivity of MEMS accelerometers, identifying the contributions for the evaluation of their reproducibility, have been presented and compared.

A group of 5 accelerometers has been tested for the purpose of developing the calibration techniques and evaluate a first reproducibility estimate.

Repeatability and reproducibility have been evaluated, using different calibration benches and processing methods.

The results provided by the two procedures showed significant differences among experimental results, to be investigated carefully. The main reasons are due to the two different excitation systems used (vertical and horizontal excitation, with respect to the gravitational field) and two different analysis procedures. It is possible that in the two calibration configurations, the position of the sensor with leads to different responses. Furthermore, the first calibration system allows to simultaneously evaluate the sensitivities along the three axes, by means of a vertical shaker, while by using the second one the axes can be calibrated only separately, by means of a linear horizontal slide; moreover, the motion of the linear slide is less subject to transverse motions, compared to shaker, in particular at low frequency. Another difference is due to different alignments (also not symmetrical) of the sensor being calibrated (MEMS) and of the reference sensor, with respect to the reference acceleration  $e$  with respect to the gravitational field. As a matter of fact, if the inclination of the MEMS sensor is not perfectly known (with respect to the axis under calibration), underestimation or overestimation of the sensitivities values easily occur.

Other possible causes of difference on the results are due to the analysis protocols used.

The calibration data determined by INRiM were calculated in matrix form, so that the contributions of the cross sensitivities do not affect the main sensitivities; furthermore, all the systematic effects of the calibration system due to the orthogonal oscillating components have been taken into consideration and are combined within the overall uncertainty budget.

With reference to the UNIVAQ calibration procedure, the reproducibility of sensitivity results is very satisfactory, if the FFT data processing method is used, in the order of  $\pm 1\%$ . In fact, this method proved to be more insensitive than the processing based on the ratio of percentiles with respect to the effect of right positioning and the presence of higher order components of vibration. If a correct relative positioning of reference sensor and of the one under calibration is guaranteed, the calibration results are unaffected by both processing methods and reference sensor.

The differences that emerged in this work offer the starting point to deepen the different aspects involved, which characterize the two different calibration procedures.

In future work, the analysed procedures will be applied to a more numerous set of MEMS accelerometers in order to get more meaningful results: refining the data processing techniques is expected to also improve the accuracy of calibration information.

The effect of some environmental conditions, like temperature will also be studied in order to better understand the accuracy of low cost MEMS accelerometer for in field applications.

#### References

- [1] D'Emilia G, Gaspari A and Natale E 2019 *Proc. IEEE Int. Instrumentation and Measurement Technology Conf. (I2MTC)* (IEEE).
- [2] Mydlarz C, Shamon C, Baglione M and Pimpinella M 2015 *Proc. of Euronoise (Netherlands)* p 1
- [3] Kardous CA and Shaw PB, 2014 *J. Acoust. Soc. Am.* **135** EL186.
- [4] Sabato A, Niezrecki C and Fortino G 2017 *IEEE Sensors Journal* **17** 226.
- [5] Barham R, Goldsmith M, Chan M, Simmons D, Trowsdale L, Bull S and Tyler R 2009 *Proc. of Euronoise ( October 26–28, 2009, Scotland)* p 1

- [6] Prato A, Mazzoleni A and Schiavi A 2019 *Proc. II Workshop on Metrology for Industry 4.0 and IoT* (Napoli) (IEEE) p 371
- [7] Schiavi A, Mazzoleni F and Germak A 2015 *Proc. XXI IMEKO World Congress on Measurement in Research and Industry* (Prague) vol 1 p 2161
- [8] D'Emilia G, Gaspari A, Mazzoleni F, Natale E and Schiavi A 2018 *J. Sens. Sens. Syst.* **7** 245
- [9] D'Emilia G, Gaspari A, Mazzoleni F, Natale E and Schiavi A 2018 *J. Sens. Sens. Syst.* **7** 403
- [10] D'Emilia G, Di Gasbarro D, Gaspari A and Natale E 2017 *J Phys Conf* 012006
- [11] D'Emilia G, Gaspari A and Natale E. 2018 *Proc. IEEE International Instrumentation and Measurement Technology Conference (I2MTC)* (IEEE)
- [12] Ye L, Argha A, Celler BG, Nguyen HT and Su SW 2017 *Sens. Actuator A Phys.* **266** 294
- [13] Frosio I, Pedersini F and Borghese NA 2012 *IEEE Sensors J.* **12** 2100
- [14] D'Emilia G, Di Gasbarro D, Gaspari A and Natale E. 2018 *Measurement* **124** 560
- [15] Bartoli C, Prasil M, Andersson H, Hof C, Schiavi A, Kolasa J, Medina N, Gazioch S, Bruns T, Licht TR, Hamalainen J 2015 *Metrologia* **52**
- [16] <https://www.st.com/resource/en/datasheet/lsm6dsr.pdf> (Last access 2020/03/23)
- [17] [https://www.st.com/resource/en/data\\_brief/32f769idiscovery.pdf](https://www.st.com/resource/en/data_brief/32f769idiscovery.pdf) (Last access 2020/03/23)
- [18] Prato A, Mazzoleni F and Schiavi A 2019 *Proc. IEEE International Workshop on Metrology for Industry 4.0 and IoT* p 371
- [19] A. Prato, F. Mazzoleni, and A. Schiavi 2020 *Metrologia* DOI: 10.1088/1681-7575/ab79be.
- [20] <https://www.bipm.org/en/cipm-mra/kcdb.html> (Last access 2020/03/23)
- [21] ISO 16063-21 2003 Methods for the calibration of vibration and shock transducers — Part 21: Vibration calibration by comparison to a reference transducer (Geneva: International Organization for Standardization)
- [22] ISO16063-11 1999 Methods for the calibration of vibration and shock transducers — Part 11: Primary vibration calibration by laser interferometry (Geneva: International Organization for Standardization)