

ISTITUTO NAZIONALE DI RICERCA METROLOGICA
Repository Istituzionale

A Characterized Method for the Real-Time Compensation of Power System Measurement Transducers

This is the author's accepted version of the contribution published as:

Original

A Characterized Method for the Real-Time Compensation of Power System Measurement Transducers / Crotti, Gabriella; Gallo, Daniele; Giordano, Domenico; Landi, Carmine; Luiso, Mario. - In: IEEE TRANSACTIONS ON INSTRUMENTATION AND MEASUREMENT. - ISSN 0018-9456. - 64:6(2015), pp. 1398-1404.

Availability:

This version is available at: 11696/50657 since: 2021-05-01T11:21:15Z

Publisher:

IEEE

Published

DOI:10.1109/TIM.2015.2398971

Terms of use:

Visibile a tutti

This article is made available under terms and conditions as specified in the corresponding bibliographic description in the repository

Publisher copyright

IEEE

© 20XX IEEE. Personal use of this material is permitted. Permission from IEEE must be obtained for all other uses, in any current or future media, including reprinting/republishing this material for advertising or promotional purposes, creating new collective works, for resale or redistribution to servers or lists, or reuse of any copyrighted component of this work in other works

(Article begins on next page)

A Characterized Method for the Real-Time Compensation of Power System Measurement Transducers

Gabriella Crotti*, Daniele Gallo†, *Member, IEEE*, Domenico Giordano*, Carmine Landi†, *Member, IEEE*, and Mario Luiso†, *Member, IEEE*

Abstract—The paper presents a real-time compensation method for the improvement of the frequency behavior of measurement transducers already operating or to be installed in transmission and distribution grids. The developed technique relies on the identification of an Infinite Impulse Response digital filter with complex frequency response equal to the inverse of the transducer, whose parameters are evaluated through a hybrid scheme based on the combination of a stochastic and a deterministic procedure. Attention is focused on the algorithm identification capability, on the sensitivity to the weighting array introduced in the optimization cost function and on the propagation uncertainty associated with the algorithm input quantities. Such investigation has been carried out on a circuit model of a resistive divider thought for medium voltage measurements. To estimate the uncertainty associated with the identified filter frequency behavior, the Monte Carlo method has been implemented. The overall improvement varies with the frequency, at 10 kHz the improvement for both the ratio as well as phase error is of two order of magnitude. The uncertainty, estimated with 10500 draws, associated with the filter is lower or equal to the input ones all over the 10 Hz – 50 kHz frequency range. The algorithm is finally applied to a laboratory resistive capacitive divider which is the low voltage stage of a medium voltage divider. The obtained improvement is of two orders of magnitude for the ratio and phase errors over all the considered frequency range.

Index Terms—Power systems, smart grids, measurements; voltage measurement; voltage divider; optimization; digital filter.

I. INTRODUCTION

THE extensive use of power electronic devices and the connection to the electricity grid of an increasing number of energy generation units from renewable resources, equipped with voltage power converters has rapidly and deeply modified the operating condition of the transmission

and distribution grid. The connection of non-linear loads, such as the switching power converter, and the intrinsic and unpredictable variability of the renewables sources may significantly affect both the quality and stability of the grid, increasing the importance of an accurate and real-time evaluation of its state. From this point of view, knowledge of the quality of the transferred power and information given by Phasor Measurement Units (PMUs) play a basic role [1]. To reduce the grid current and voltage to levels compatible with the input of the PMUs and Power Quality (PQ) measuring instruments, current and voltage transducers have to be used. These transducers are expected to accurately scale and input to the measuring instrument the voltage/current waveforms over a proper range of amplitudes and frequencies, so that the measuring instrument can evaluate the required parameters and indexes according to the relevant standards [2] – [4]. The frequency response of the used transducers is then a critical element, in particular if considering that in most cases the already installed measurement or protection instrument transformers are used and no information is generally available on the errors introduced at frequencies higher than the fundamental one [5] – [8].

Methods for the corrections of the frequency response for both transducers [9], [10] as well as acquisition systems [11] – [14] have been developed and implemented. A number of them are based on the correction in the frequency domain of the signal components, starting from the measured transducer response. This technique ensures high accuracy performances, but requires a high computational burden and cannot be exploited in real-time applications. A second approach bases on the introduction of Finite Impulse Response (FIR) digital filters whose transfer function is equal to the inverse of the one to be compensated. In this case the deterministic algorithm used for the filter identification is quite sensitive to the initial point; satisfactory accuracy may be reached only with high order filters, which cannot be implemented on a low cost processor. In addition, the use of FIR filters introduce a finite delay in the phase response.

The paper focuses on a real time compensation procedure based on the identification of an Infinite Impulse Response (IIR) digital filter, with complex frequency response equal to the inverse of the transducer one and whose parameters are evaluated through a hybrid scheme based on the combination

The research leading to the results here described is part of the European Metrology Research Program (EMRP), ENG52 Smart Grid II project. The EMRP is jointly funded by the EMRP participating countries within EURAMET and the European Union.

G. Crotti and D. Giordano are with the Istituto Nazionale di Ricerca Metrologica, 10129 Torino, Italy (e-mail: g.crotti@inrim.it, d.giordano@inrim.it).

D. Gallo, C. Landi and M. Luiso are with the Department of Industrial and Information Engineering, Second University of Napoli, 81031 Aversa, Italy (email: daniele.gallo@unina2.it, carmine.landini@unina2.it, mario.luiso@unina2.it).

of a stochastic and deterministic procedure. The method is intended for implementation on Field Programmable Gate Array (FPGA), equipped with analog-to-digital (A/D) and digital-to-analog (D/A) converters. The compensation technique can be applied both to already operating instrument transformers or new transducers.

The technique discussed here was already presented in previous papers [15]-[18], where it was applied to the compensation of the response of transducers with different frequency behavior, like current instrument transformer and Hall-effect voltage and current transducers, obtaining considerable performance improvements. However, metrological performance of such technique has not been thoroughly evaluated. In this paper the technique is extended to the correction of voltage transducer response, in the frequency range from 10 Hz up to 50 kHz. Attention is specifically focused on the evaluation of its reconstruction capabilities and on the propagation of the measurement uncertainties through the compensation algorithm. After a brief description of the compensation technique given in Section II, Section III analyses the accuracy performances and reconstruction capabilities of the developed techniques by considering a voltage transducer, whose “true” frequency response is analytically defined starting from its circuit model. The propagation through the numerical technique of the input measurement uncertainties to the evaluated filter coefficient and frequency compensated behavior is dealt with in last part of Section III, whereas Section IV presents an example of application to the compensation of the frequency response of an actual voltage divider.

II. THE COMPENSATION TECHNIQUE

Real time compensation of the unsatisfactory frequency response of a transducer can be obtained if a device with a transfer function equal to the transducer inverse transfer function is cascaded to it. To this end, a filter can be adopted, whose transfer function $H(f)$ has to be determined for any frequency f in the range of interest, starting from an accurate frequency characterization of the device in a limited number N_f of points [15]. The implementation of the filter transfer function by an analog circuit is not an easy task and can lead to satisfactory results only if applied to a limited frequency range.

Better results can be obtained by implementing it by a digital filter on a Field Programmable Gate Array (FPGA), embedded in a Reconfigurable I/O platform with A/D and D/A converters (Fig.1).

Under the assumption of a low linearity error of the considered device, an IIR filter is considered. Such a filter allows the reconstruction of the desired frequency response with a limited number of coefficients, without introducing significant phase delay. As known, the model of the IIR filter can be factorized as:

$$H(z) = K \prod_{k=1}^N \frac{1 + b_{1,k} z^{-1} + b_{2,k} z^{-2}}{1 + a_{1,k} z^{-1} + a_{2,k} z^{-2}} \quad (1)$$

where Second Order Sections (SOSs) are chosen for the

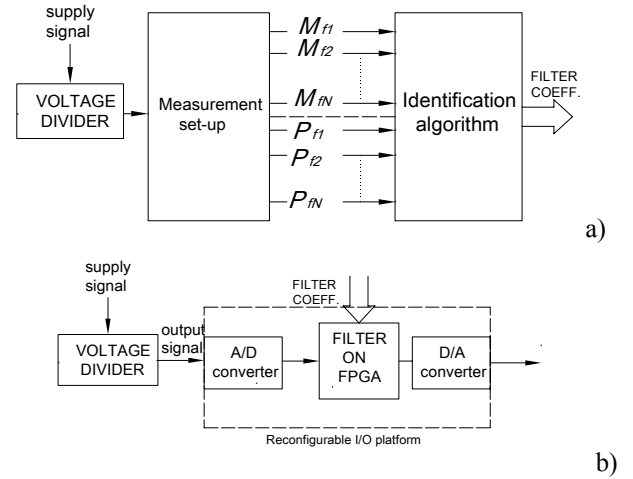

Fig. 1. Scheme of the implementation of the proposed procedure:

a) offline identification procedure; b) real time compensation.

factors, because of the resulting lower sensitivity of the frequency response to changes in the coefficient values. The number N of factors can be properly chosen depending on the frequency behavior to be compensated. Therefore, the best values for the $4N+1$ parameters, i.e. the gain K and four coefficients for N SOSs, are to be determined.

The problem of choosing the best coefficients can be formulated as an inverse problem and solved by optimization techniques [19], [20]. A suitable objective function $C(\mathbf{P})$, quantifying the difference among target frequency response ($H_d(f_i)$) and obtained values in the N_f points, is then defined according to:

$$C(\mathbf{P}) = \frac{1}{2} \sum_{i=1}^{N_f} W(f_i) \cdot \left[\log_{10} \frac{H(f_i, \mathbf{P})}{H_d(f_i)} \right]^2 \cdot \left[\log_{10} \frac{f_{i+1}}{f_{i-1}} \right] \quad (2)$$

Where \mathbf{P} is the vector of the $4N+1$ filter coefficients and $W(f_i)$ is a weight function. Function $C(\mathbf{P})$ is minimized by an optimization algorithm which implements a combined stochastic and deterministic approach [15].

The accuracy performances of the compensation method depend, firstly, by the intrinsic capabilities of the optimization technique of identifying the better filter frequency response. In addition, the reconstructed frequency behavior is affected by the measurement uncertainties of the frequency response discrete values, which are the process input quantities.

III. ANALYSIS OF RECONSTRUCTION CAPABILITIES

The reconstruction capabilities of the considered technique are numerically investigated by considering the circuit model of a medium voltage (MV) resistive divider.

A. Resistive divider circuit model

As a first application of the compensation technique, we consider a resistive divider for phase-to-earth measurement in a MV network. The divider was designed to reduce the 100 V output voltage of a 30 kV resistive capacitive divider to 1 V and, in the same time, to compensate the frequency behavior of the above mentioned MV divider. This characteristic gives

the peculiar frequency behavior and makes it attractive as bench mark. Assuming a rated phase-to-earth voltage of tens of kilovolts, an equivalent resistance of at least tens of megaohm for the divider high voltage arm is essential to limit power dissipation. Such a resistive value amplifies the effect of the stray capacitances among the high voltage (HV) arm components on the divider frequency behavior. This can limit the use of the transducer in the harmonic range, e.g. in PQ analysis. Fig. 2 gives the equivalent circuit of the divider. U_p and U_s are the primary and secondary voltage, R_{HV} and R_{LV} are the equivalent resistance of the high voltage (HV) and low voltage (LV) arm respectively and C_{HV} is the equivalent stray capacitance of the HV arm. Their imposed values are summarized in Table I.

The frequency behavior of such a transducer is described by the relations:

$$SF(f) = \frac{U_p}{U_s} = SF_0 \cdot \frac{\sqrt{1 + \left(\frac{f}{f_c}\right)^2}}{\sqrt{1 + \left(\frac{f}{\frac{f_c}{SF_0}}\right)^2}} \quad (3)$$

$$\Delta\phi(f) = \arctan\left[\frac{f}{\frac{f_c}{SF_0}}\right] - \arctan\left[\frac{f}{f_c}\right]$$

where $SF(f)$ is the divider scale factor (inverse of the transfer function magnitude) and $\Delta\phi(f)$ is the phase error defined as the phase displacement between the secondary and the primary voltage. SF_0 is the DC scale factor and f_c is the pole of the divider transfer function given by:

$$f_c = \frac{1}{2\pi} \cdot \frac{R_{HV} + R_{LV}}{R_{HV} \cdot R_{LV} \cdot C_{HV}} \quad (4)$$

Fig. 3 shows the frequency behavior of $SF(f)$ and $\Delta\phi(f)$ from 10 Hz to 100 kHz. Taking into account the accuracy limit for ratio and phase errors of instrument transformer used in PQ [21] (5% for the ratio error and 90 mrad for the phase error

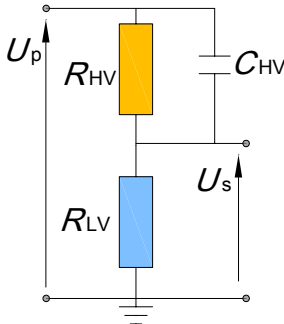

Fig. 2. Equivalent circuit of the theoretical voltage divider

TABLE I
DIVIDER CIRCUIT PARAMETERS

quantity	rated value
R_{HV}	30 M Ω
R_{LV}	3 k Ω
C_{HV}	0.8 pF
SF_{rated}	10001

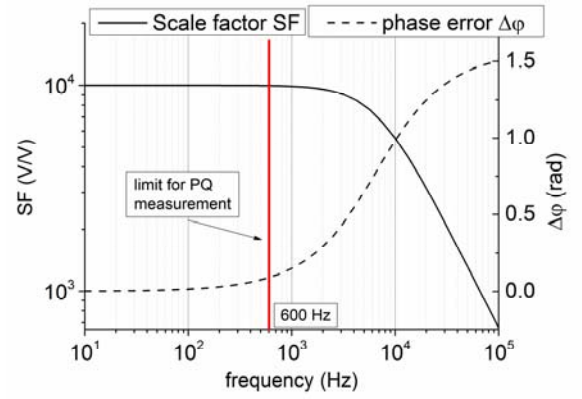

Fig. 3. Computed scale factor and phase error of the resistive divider

from the third to the 50th harmonic and over), the red vertical line at 600 Hz highlights the limited useful bandwidth for this divider.

B. Analysis of the identification algorithm performances

According to the procedure summarized in Section II, the first step is the definition of the filter model. The considered divider is a first order high pass filter with one pole (at $f = 66$ MHz) and one zero (at $f = 6600$ Hz). The compensation digital filter should then be of the same order. However, because of the SOS factorization (1) choice, as discussed in Section II, a second order digital filter ($N=1$) is used.

The next step is the definition of the objective function (2). As a first choice, a unitary weighting array is introduced. The overall improvement introduced by the optimized digital filter is evaluated in terms of two indexes (imp_ratio and imp_phase), computed according to:

$$imp_ratio = \frac{|dr|}{\frac{1}{N_f} \cdot \sum_{i=1}^{N_f} \left[\frac{H_{filter}(f_i)}{SF(f_i)} - 1 \right]}$$

$$imp_phase = \frac{|dp|}{\frac{1}{N_f} \cdot \sum_{i=1}^{N_f} \left[\Delta\phi(H_{filter}(f_i)) - \Delta\phi(SF(f_i)) \right]} \quad (5)$$

where dr and dp are the absolute means of the uncompensated divider ratio and phase errors respectively, as defined by [21], computed over the range 10 Hz to 90 kHz, while $N_f=40$ is the number of sampled frequency points. The obtained index values are 72 and 38 for the SF and phase error respectively. The frequency analysis of the ratio and phase errors for the measurement chain composed by cascading the divider and the optimized digital filter is shown in Fig. 4. The compensation significantly reduces (about two orders of magnitude) both the ratio and phase error at the higher frequencies. However, the presence of the filter considerably worsens the response in the range 10 Hz to 200 Hz: the divider SF error increases from about 28 μ V/V to 1 mV/V at 50 Hz (see inset in Fig. 4).

Since the higher accuracy is required at the lower frequencies, we investigated the improvement obtained by setting the first 20 elements of the weighting array, i.e. from 10 Hz to 900 Hz, with a constant weight w , whose value was varied in the range

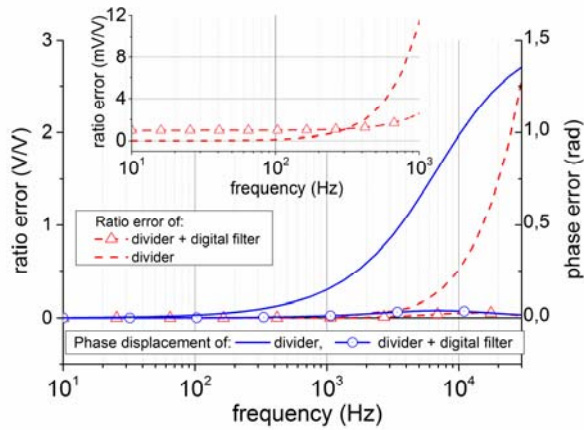

Fig. 4. Frequency behavior of ratio and phase error of the divider and the chain divider + digital filter. The ratio error frequency zoom highlights the higher error for the compensated divider between 10 Hz and about 200 Hz.

TABLE II

RATIO AND PHASE IMPROVEMENT COEFFICIENT FOR DIFFERENT WEIGHTS

w	1	50	250	500	1000
Imp_ratio	72	50	69	66	63
Imp_phase	38	72	63	81	102

50 to 1000. The obtained results are summarized in Fig. 5 for the different w values, whereas Table II shows the corresponding overall improvement indexes.

At the increase of the weight, an increasing improvement on the ratio error up to 30 kHz is detected, while, for higher frequencies, a worst performance is obtained. As to the phase,

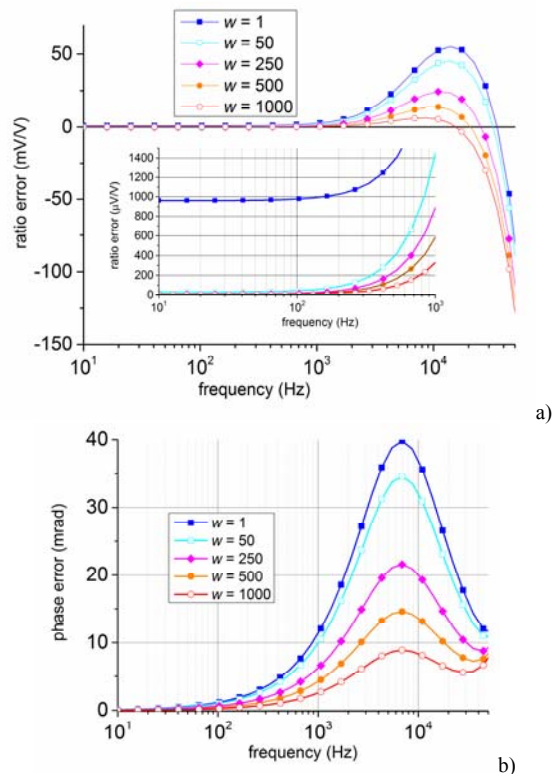

Fig. 5. Frequency behaviors of the divider+filter ratio a) and phase b) error obtained by weighing, in the same way, the first 20 samples of the algorithm input with increasing weight w .

the increasing weight produces an error reduction up to 50 kHz. On the basis of the obtained results a weighting array is chosen which gives satisfactory ratio and phase errors up to 50 kHz: the weight of the first 20 samples is set at 500, the next 10 samples are assigned a 100 weight, whereas the last 10 have a unitary weight.

A comparison between the ratio and phase errors of the compensated divider (COMP) and of the uncompensated one (UNC) is provided in Table III at 50 Hz, 2.5 kHz and 10 kHz. As regards the ratio error, we can see that there is a little worsening at 50 Hz: it increases from 0.028 mV/V to 0.066 mV/V. Anyway, the procedure introduces such a little increase in order to obtain more significant reductions at higher frequencies. Instead, for the higher frequencies an increasing improvement is recorded, i.e. of a factor from 200 to 500. As regards the phase error, the compensation improves considerably the phase error in all the considered frequency range: a reduction of a factor from 200 to about 400, can be observed.

The output repeatability due to the stochastic algorithm has been quantified by computing the relative standard deviation associated with the ratio and phase error of the compensated divider over 300 repeated computations assuming, as an input, the rated scale factor and phase error of the resistive divider. In the 10 Hz to 50 kHz frequency range the standard deviation is always lower than 0.2 μ V/V (relative value) and 0.2 μ rad, therefore we can disregard this very low variability.

C. Propagation of the measurement uncertainty

To estimate the propagation of the measurement uncertainty of the divider SF and phase error measurement, the Monte Carlo method (MCM) is adopted. Input standard measurement uncertainties of relatively low value are assumed for the

TABLE III
RATIO AND PHASE ERRORS OF THE UNCOMPENSATED AND COMPENSATED DIVIDERS

Frequency (Hz)	Ratio error (mV/V)		Phase error (mrad)	
	COMP	UNC	COMP	UNC
50	0.066	0.028	0.041	7.5
2500	0.35	69	1.5	360
10000	1.5	800	2.3	985

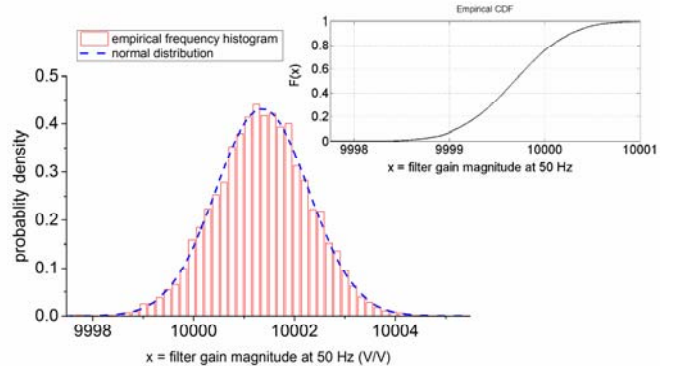

Fig. 6. Frequency histogram and cumulative density function (10500 draws) of the filter gain magnitude at 50 Hz. Comparison between the frequency histogram and the normal distribution whose parameters are estimated by MCM

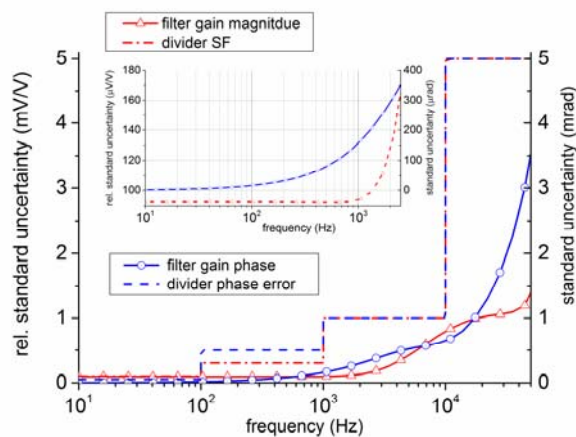

Fig. 7. Comparison between input standard uncertainties associated with the divider SF and phase delay (dashed piece-wise lines) with those calculated for the compensation filter gain (continuous lines).

divider SF and phase delay, with a normal probability density function (PDF). To reduce the computation time, the number of draws has been limited to 10500, sufficient to ensure stabilization of the MCM outputs. Fig. 6 shows the empirical PDF and cumulative (CDF) density function associated with the filter gain magnitude at 50 Hz. The reliability of the MCM outputs is proved by the comparison between the empirical PDF and the normal distribution (see Fig. 6) computed by introducing the mean value and the standard deviation given by the MCM. Fig. 7 compares the input standard uncertainties associated with the frequency sample of the divider SF and phase delay (dashed piece-wise lines) with those calculated for the compensation filter gain (continuous lines). In the first frequency decade, the input uncertainties and that given by the MCM are comparable. For higher frequency, the deviation between input and output uncertainties become higher, in particular, the output uncertainties are always lower than the input one. This can be explained by the higher weight associated with the samples at lower frequencies. Consequently, their propagation to the filter gain, through the reconstruction procedure, affects the results at the higher frequencies.

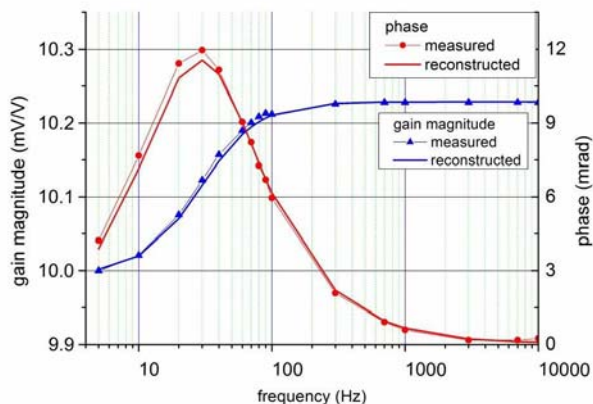

Fig. 8. Comparison between RCD measured frequency behavior and the inverse of the identified compensation filter

IV. EXPERIMENTAL VALIDATION

The filter reconstruction performances estimated by the simulation are investigated by applying it to the compensation of a LV divider. The considered transducer is a resistive-capacitive 100 V / 1 V voltage divider (RCD) originally designed for the attenuation and frequency response adjustment of a medium voltage sensor.

A. Measurement of the transducer frequency response

The first step is the measurement of the magnitude ($G_{RCD}=SF^{-1}$) and phase of the transducer gain frequency response. To this end, a measurement system is used that consists of a Data Acquisition board (DAQ) from National Instruments with 4 simultaneous ± 10 V (16 bits) acquisition channels, a maximum sampling frequency of 1 MHz and a 10 M Ω input impedance. The RCD applied voltage ($V_{rms} = 7$ V) is supplied by a Fluke 5500 calibrator; the same DAQ is used to acquire both the RCD applied and output voltage. As a first step, the investigated frequency range is set to 10 kHz. The measured RCD gain magnitude (SF^{-1}) and phase displacement are shown in Fig. 8. The estimated relative uncertainties (level of confidence 95%) are 0.20 mV/V to 0.60 mV/V for the gain and 10 μ rad to 50 μ rad for the phase. The RCD transfer function shows a maximum phase error (12 mrad) around 30 Hz, and a maximum relative difference from the DC gain magnitude of $2.3 \cdot 10^{-2}$ (Fig. 8).

B. Filter identification

A preliminary analysis, carried out increasing the number of the SOS sections, leads to the choice of a N=2 SOS factors for the filter model (1). The optimization procedure is then run to identify the (4N+1) filter coefficients, by assuming the same unitary value for all the frequencies. The inverse of the obtained compensating filter transfer function is compared in Fig. 8 with the measured data.

The maximum absolute differences between the divider measured frequency behavior and the inverse of the reconstructed filter function are within 0.009 mV/V (at 40 Hz) and 0.6 mrad (at 30 Hz) for the gain magnitude and phase respectively over the range from DC to 100 Hz; they further reduce with the increase of the frequency down to 0.001 mV/V and 150 μ rad at 10 kHz. Considering the divider ratio and phase errors (19 mV/V and 9 mrad at 60 Hz), the compensation obtained with unitary weight leads to a ratio and phase error of 0.5 mV/V and 0.014 mrad respectively. The improvement indexes imp_ratio and imp_phase are found to be close to 100 over all the considered frequency range.

V. CONCLUSIONS

A compensation method for the improvement of the frequency behavior of measurement transducers already operating or to be installed in transmission and distribution grids, suitable to be implemented in real-time application, has been extensively characterized to evaluate its performances. Both the characterization results obtained by applying it to simulated devices as well as the experimental application to the compensation of a resistive-capacitive divider show how

the developed technique allows the compensation of the voltage transducer behavior from 10 Hz to 10 kHz, reducing its frequency response errors of a factor enclosed between 1 and 3 orders of magnitude, depending on the frequency value.

We also demonstrate that the standard deviation associated with the digital filter response due to the only stochastic process is lower than $0.2 \mu\text{V/V}$ and $0.2 \mu\text{rad}$ in the 10 Hz to 50 kHz frequency range, thus it can be disregarded.

The MCM provides uncertainties always lower or equal to the input measurement ones.

The proposed approach, could also be applied in the identification of a digital filter for the compensation of transducers belonging to the same family which is characterized by a defined tolerance.

Presently, additional numerical and experimental verification are in progress to evaluate the performances of the method when applied to the correction of MV voltage instrument transformer response.

References

- [1] G. Sanchez-Ayala, J.R. Aguerre, D. Elizondo, M. Lelic, M., "Current trends on applications of PMUs in distribution systems, in *Proc. of IEEE ISGT*, 2013, pp.1-6.
- [2] IEEE Guide for Synchronization, Calibration, Testing, and Installation of Phasor Measurement Units (PMUs) for Power System Protection and Control, IEEE standard C37.242™-2013.
- [3] Electromagnetic Compatibility (EMC) Part 4-30: Power quality measurement methods, IEC standard 61000-4-30, 2008
- [4] Electromagnetic Compatibility (EMC) Part 4-7: "General guide on harmonics and interharmonics measurements and instrumentation for power supply systems and equipment connected thereto", IEC standard 61000-4-7, 2009.
- [5] M. H. J. Bollen, F. P. F. Ribeiro, E. O. A. Larsson and C. M. Lundmark, "Limits for Voltage Distortion in the Frequency Range 2 to 9 kHz", *IEEE Trans. Power Delivery*, vol. 23, no.3, pp. 1481-1487, July 2008.
- [6] J. Luszcz and R. Smolenski, "Voltage Harmonic Distortion Measurement Issue in Smart-Grid Distribution System", in *Proc. of Asia-Pacific International Electromagnetic Compatibility Symposium (APEMC)*, 2012, pp. 841-844.
- [7] D. Patel, R. K. Varma, R. Seethapathy and M. Dang, "Impact of Wind Turbine Generators on Network Resonance and Harmonic Distortion", in *Proc. of Canadian Conference on Electrical and Computer Engineering (CCECE)*, 2010, pp. 1-6.
- [8] IEC/TR 61869-103 "Instrument transformers - The use of instrument transformers for Power Quality measurements", 2012.
- [9] C. De Capua, C. Landi, "Measurement Station Performance Optimization for Testing on High Efficiency Variable Speed Drives", *IEEE Trans. Instrum. Meas.*, vol 48, no. 6, pp. 1149-1154, Dec. 1999.
- [10] G. Dantona, A. Ferrero, R. Ottoboni, "Bandwidth enhancement of an insulated voltage to voltage transducer via digital compensation for industrial applications", in *Proc. of IEEE Instrumentation and Measurement Conference (IMTC)*, 1998, pp. 380-384 .
- [11] R. Pintelon, Y. Rolain, M.V. Bossche, J. Schoukens, "Towards an ideal data acquisition channel", *IEEE Trans on Instrum. Meas.*, vol. IM-39, no. 1, pp. 116-120, Feb 1990.
- [12] I. Kollar, R. Pintelon, Y. Rolain, J. Schoukens, "Another step towards an ideal data acquisition channel", *IEEE Trans. Instrum. Meas.*, vol IM-40, no. 3, pp. 659-660, June 1991.
- [13] G. Rietveld, D. Zhao, C. Kramer, E. Houtzager, O. Kristensen, C. de Lefte, and T. Lipper, "Characterization of a Wideband Digitizer for Power Measurements up to 1 MHz", *IEEE Trans. Instrum. Meas.* vol. 60, no. 7, July 2011, pp. 2196 – 2200.
- [14] I. Kollar, Y. Rolain, "Complex correction of data acquisition channels using FIR equalizer filters", *IEEE Trans. Instrum. Meas.*, vol. IM-42, no 5, pp. 920 – 924, Oct. 1993.
- [15] D. Gallo, C. Landi and M. Luiso, "Real Time Digital Compensation of Current Transformers over a Wide Frequency Range", *IEEE Trans. Instrument. Meas.*, vol. 59, no.5, pp. 1119-1126, May 2010.
- [16] A. Delle Femine, D. Gallo, C. Landi, M. Luiso, "Power Quality Monitoring Instrument with FPGA Transducer Compensation", *IEEE Trans. Instrum. Meas.*, Vol. 58, no. 9, pp: 3149 – 3158, Sept. 2009.
- [17] G. Crotti, D. Gallo, D. Giordano, C. Landi, M. Luiso, "FPGA-based real time compensation method for medium voltage transducers", ACTA IMEKO, in press.
- [18] G. Crotti, D. Gallo, D. Giordano, C. Landi and M. Luiso, "A Characterized Method for the Real-Time Compensation of Power System Measurement Transducers", in *Proc. Conference on Precision Electromagnetic Measurement (CPEM) 2014*, Rio de Janeiro, Brasil, Aug. 2014.
- [19] J. Kaipio and E. Somersalo, *Statistical and Computational Inverse Problems*, ser. Applied Mathematic Sciences. New York: Springer-Verlag, 2005.
- [20] K. Deb, *Multiobjective Optimization Using Evolutionary Algorithms*. Hoboken, NJ: Wiley, 2001.
- [21] Instrument Transformer - Part 8: Electronic current transformer, IEC standard 60044-8, 2002.