



## ISTITUTO NAZIONALE DI RICERCA METROLOGICA Repository Istituzionale

Evaluation of the measurement capabilities of an high performance commercial high resistance bridge by means of the comparison with two validated high resistance

*Original*

Evaluation of the measurement capabilities of an high performance commercial high resistance bridge by means of the comparison with two validated high resistance measurement methods / Galliana, Flavio; Capra, PIER PAOLO; Gasparotto, E.. - (2015), p. 10001. (Intervento presentato al convegno 17th International Congress of Metrology tenutosi a PARIGI nel LUGLIO 2015) [10.1051/metrology/20150010001].

*Availability:*

This version is available at: 11696/52491 since: 2021-03-02T23:13:19Z

*Publisher:*

French College of Metrology

*Published*

DOI:10.1051/metrology/20150010001

*Terms of use:*

Visibile a tutti

This article is made available under terms and conditions as specified in the corresponding bibliographic description in the repository

*Publisher copyright*

(Article begins on next page)

# Evaluation of the measurement capabilities of an high performance commercial high resistance bridge by means of the comparison with two validated high resistance measurement methods

F. Galliana<sup>1</sup>, P.P. Capra<sup>2</sup> and E. Gasparotto<sup>3</sup>

<sup>1, 2, 3</sup> National Institute of Metrological Research, strada delle Cacce 91, 10135 TURIN – Italy

<sup>1</sup> +39 0113919336, f.galliana@inrim.it

<sup>2</sup> +39 0113919424, p.capra@inrim.it

<sup>3</sup> +39 0113919425, e.gasparotto@inrim.it

**Resumé.** À l'Institut national de la métrologie de recherche (INRIM) ont réalisée une comparaison de mesure entre un pont de mesure de haute résistance électrique commerciale et deux méthodes de mesure de haute résistance électrique validée utilisé à l'INRIM. Ils ont procédé à une estimation de l'incertitude de mesure du pont à partir de 10 GΩ jusqu'à 10 TΩ. Quatre étalons de haute résistance de haut niveau à partir de 10 GΩ jusqu'à 10 TΩ ont été calibrés avec les trois méthodes de mesure. La compatibilité de ces mesures était bon. Quelques problèmes pour les mesures plus de 10 TΩ et dans l'évaluation de l'incertitude de mesures du pont, cependant, restent en suspens.

## 1 Introduction

At National Institute of Metrological Research (INRIM) high Dc Resistance measurements in the range from 1 GΩ to 100 TΩ are currently operated with two measurement methods. The first, based on a DC Voltage calibrator (DCV Cal) and a digital multimeter (DMM) can operate in the range 10 MΩ +1 TΩ but is normally utilized at INRIM only from 1 GΩ [1]. With this method INRIM participated with satisfactory results at the comparison [2] performing the measurements at 1 GΩ and at the comparison [3] performing the measurements at 1 TΩ. With the second method, based on a modified Wheatstone bridge, operating at INRIM in the range from 100 GΩ to 100 TΩ with two DCV Cals in the active arms of the bridge [1] INRIM participated at the comparison [3] performing the measurements at 1 TΩ and at 100 TΩ with satisfactory results. Nevertheless, recently INRIM acquired a high performance fully automated high resistance commercial bridge operating in the range from 100 kΩ to 10 PΩ whose operation mode is based on a similar principle [4]. This instrument could be very useful for its wide measurement field and because it allows to speed some technical operations as the measurement data processing, needed for the increasing amount of requested calibrations as it has an internal software that processes the data and gives out a simply file with all the needed information as ratio and resistance values and ratio standard deviation. In this paper a short description of the commercial bridge, a preliminary uncertainty

evaluation of the measurement in the range 10 GΩ–10 TΩ, the evaluation of the calibration of four high value Resistance Standards covering the above range with the commercial bridge and with the two validated INRIM high resistance methods to check the reliability and compatibility of the new bridge measurements, some considerations about the best measurement settle times, are given.

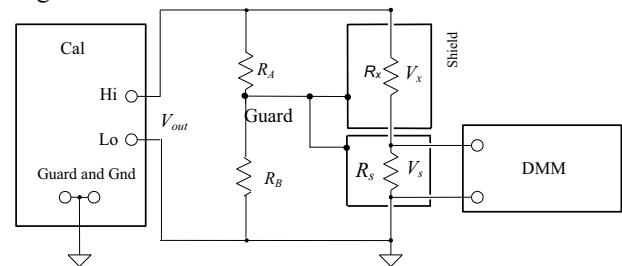

**Figure 1.** Scheme of the DMM-calibrator (DMM Cal) measurement method.

Corresponding author: f.galliana@inrim.it

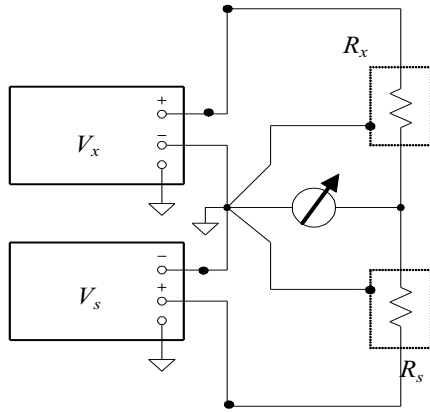

Figure 2. Scheme of the modified Wheatstone bridge (INRIM bridge).

## 2 The high resistance commercial bridge

The high performance fully automated Dual Source High Resistance bridge covers a wide calibration measurement field from 100 kΩ to 10 PΩ from 1 V to 1000 V. It can compare two resistors in 10:1 or 100:1 ratios or make direct measurement as a teraohm-meter. It uses two programmable DC Voltage calibrators and a null detector controlled via IEE488 interface bus.

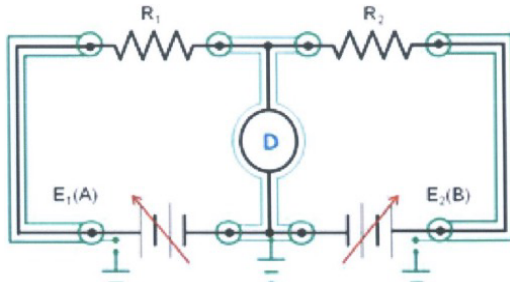

Figure3. Measurement scheme of the high Resistance bridge [4].

Also it is based on the Wheatstone bridge technique, the low impedance of the detector implies that the current flowing in each resistor connected to the bridge depends on the voltage applied on it by the calibrator. The voltage ratio is established so that the currents in the two resistors are in opposition and the bridge balance is reached when their difference is 0. Nevertheless, the bridge does not reach the complete balance but only approaches it while the detector measures the unbalance relative to a circuit zero (Fig. 3). Uncertainty specifications of the bridge provided by the manufacturer are shown in Fig. 4.

Measurement Range (Ohms)	Applied Voltage	Live Ratio Mode Uncertainty		Direct Measurement
		1:1 and 10:1 Ratio	100:1 Ratio	
100k to 1M	1 to 100V	<7	<20	<80
1M to 10M	1 to 100V	<7	<20	<80
10M to 100M	10 to 1000V	<7	<20	<80
100M to 1G	10 to 1000V	<7	<20	<80
1G to 10G	10 to 1000V	<8	<30	<100
10G to 100G	10 to 1000V	<10	<30	<200
100G to 1T	10 to 1000V	<15	<50	<400
1T to 10T	100 to 1000V	<20	<80	<600
10T to 100T	100 to 1000V	<30	<100	<2000
100T to 1P	100 to 1000V	<100	<400	<0.5%
1P TO 10P	100 to 1000V	<100	<600	<3%

1. Uncertainty confidence level: 95%
2. Uncertainties relative to calibration standards used and are independent of reference resistor or UUT uncertainty contributor
3. Does not include settle time, dielectric or voltage coefficient etc. for resistor being measured.

Figure 4. 2σ type B accuracy specifications of the high Resistance commercial bridge.

As reported in the notes, these specifications cover only the type B uncertainty of the measurement ratios and do not take into account the uncertainty due to the reference resistor, the settle time, the repeatability of the ratio and the characteristics and environment conditions of the resistor under calibration. Nevertheless, starting from this table a first uncertainty budget regarding the calibration of four INRIM high value Standard Resistors in the range 10 GΩ–10 TΩ was made. In Table 1 the uncertainty budget of the 1 TΩ resistor at 1000 V is exploited.

Table 1. Preliminary uncertainty budget for the calibration of a 1 TΩ standard resistor at 1000 V with the new commercial high resistance bridge in 10:1 ratio with a 100 GΩ resistor.

Source	Prob. distr.	1 σ uncertainty (μΩ/Ω)
Rs	B	17.0
Repeatability	A	3.6
Connections	B	5.8
Balance	B	17.3
Stabilization	B	20.2
Sensitivity	B	13.9
Leakage	B	5.8
Bridge	B	7.5
$u(R_x)$		40.6
$U(R_x)$		92.7

In the  $R_s$  component are included its calibration, environment effects, drift, voltage dependence uncertainty components. Nevertheless, this is only a preliminary budget and contacts with technicians of the bridge manufacturer are underway to establish a reliable criterion to evaluate the uncertainties of the measurements made with the bridge. The evaluated uncertainties in the range 10 GΩ–10 TΩ at 100 V, 500 V and 1000 V for the calibration of four high performance INRIM Resistance Standards are summarized in Table 2.

**Table 2.** Summary of the uncertainties in the calibration of four high performance INRIM standard resistors at three voltages with the new commercial high resistance bridge.

Resistor	Meas. Voltage	$U(R_x)$ ( $\mu\Omega/\Omega$ )
10 G $\Omega$	100 V	18
	500 V	17
	1000 V	17
100 G $\Omega$	100 V	36
	500 V	35
	1000 V	34
1 T $\Omega$	100 V	96
	500 V	97
	1000 V	93
10 T $\Omega$	500 V	270
	1000 V	220

### 3 Compatibility test between the INRIM methods and the high resistance bridge.

A first compatibility test between the INRIM high resistance methods and the high resistance commercial bridge was made comparing the calibration values of four high performance high value standard resistors in the range 10 G $\Omega$ ÷10 T $\Omega$ . Table 3 shows the obtained results for each resistor at three voltages with the three methods along with their expanded uncertainties. The DMM-Cal method was involved in the measurements till up to 1 T $\Omega$ , while the measurements at 10 T $\Omega$  were made only at 500 V and 1000 V. The measurements with the two bridges were made in scaling 1:10 ratios. All the measurement results are expressed as relative deviation from nominal value.

**Table 3.** Comparison results between INRIM methods and the commercial for high resistance measurements. The measurement values are expressed as relative deviation from their nominal values.

Resistor	Voltage (V)	DMM Cal ( $\times 10^{-6}$ )	$U_{DMM-Cal}$ ( $\times 10^{-6}$ )	INRIM Bridge ( $\times 10^{-6}$ )	$U_{INRIM\_bridge}$ ( $\times 10^{-6}$ )	Commercial bridge ( $\times 10^{-6}$ )	$U_{comm\_bridge}$ ( $\times 10^{-6}$ )
10 G $\Omega$	100	162.5	75	192.6	34	181.8	18
	500	134.7	31	150.6	33	121.2	18
	1000	110.5	34	102.6	35	99.2	17
100 G $\Omega$	100	-69.0	70	-75	71	-44	36
	500	-47.9	98	-67	68	-79	35
	1000	-46.2	70	-73	69	-51	34
1 T $\Omega$	100			1711	220	1624	96
	500	1363	240	1430	100	1391	97
	1000	1709	230	774	99	747	93
10 T $\Omega$	500			-16717	370	-16882	270
	1000			-18294	360	-18580	220

In Figure 5 –8 the comparison results in graphical way are also shown.

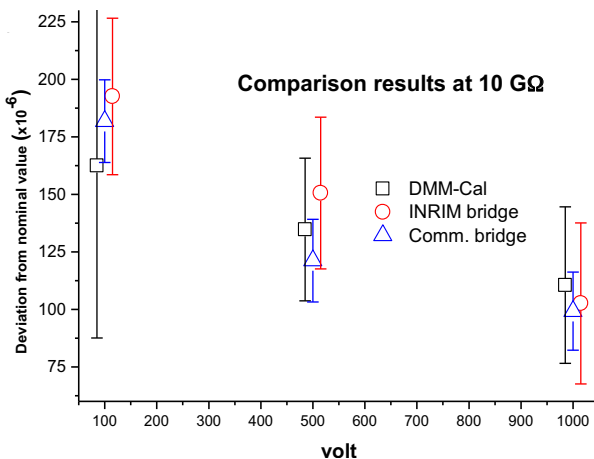

**Figure 5.** Compatibility results at 10 G $\Omega$ .

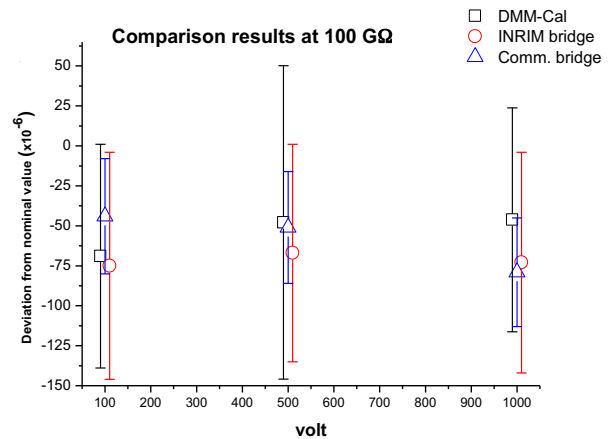

**Figure 6.** Compatibility results at 100 G $\Omega$ .

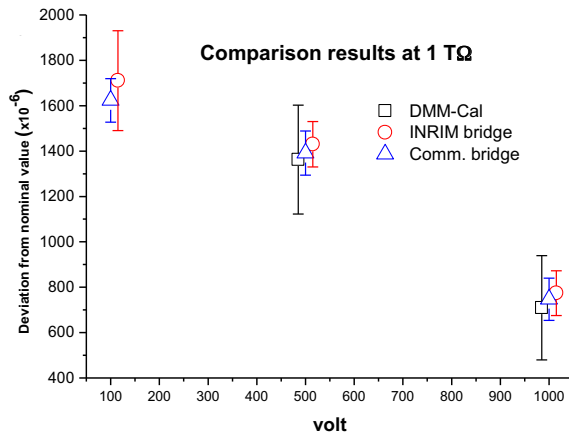

**Figure 7.** Compatibility results at 1 TΩ. The measurement at 100 V with the DMM-Calibrator method was not performed.

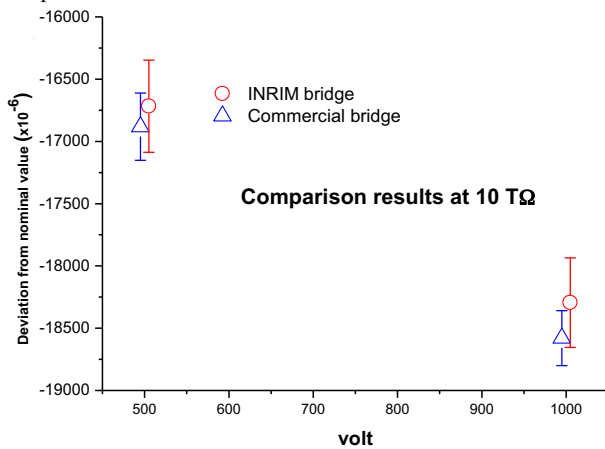

**Figure 8.** Compatibility results at 10 TΩ.

#### 4. Discussion and open problems.

From Table 3 and figures 5–8 the first compatibility test of the measurement results between the INRIM methods and the commercial bridge in the range 10 GΩ–10 TΩ could be considered satisfactory. Concerning the measurements at 1 TΩ and 10 TΩ the best results were achieved setting on the commercial bridge settle times respectively of 180 s and 360 s, much higher than suggested by the manufacturer instruction manual. Nevertheless, some problems still remain open. For example, the uncertainty budget has to be improved as it not clear from the user manual if the bridge specifications are always valid or limited to a definite time after DCV sources calibration, if specifications, drift, calibration uncertainties of the DCV sources and of the detector are taken into account, if the measurement criterion to evaluate the uncertainties reported in the specifications is correct. Another problem occurred at 100 TΩ as the measurement with the commercial bridge resulted not compatible with that of the INRIM bridge or even not achievable both in 1:10 and 1:100 ratios and even in direct measurement. Then, the operation mode of the commercial bridge for values higher than 10 TΩ as well its internal software have to be further investigated in particular when the deviation of the value of the resistor

under calibration with respect its nominal value is significant.

#### References

1. Galliana, F. Capra P.P., Gasparotto E", IEEE Trans. Instrum. Meas., **60**,3, pp.965– 970, (2011).
2. Dziuba R. F. and Jarret. D. G., Metrologia, **39**, p. 01 001, (2002).
3. Jeckelmann B. et al, METROLOGIA, **50**, ISSN: 0026– 1394, (2013).
4. Jarrett D. G." IEEE Trans. Instrum. Meas, **46** 2, pp. 325–328, (1997).