



ISTITUTO NAZIONALE DI RICERCA METROLOGICA Repository Istituzionale

The IMGCC Hardness Standard Machine. Description of the actual software and of proposed modifications

Original

The IMGCC Hardness Standard Machine. Description of the actual software and of proposed modifications / Barbato, G; Germak, ALESSANDRO FRANCO LIDIA; Desogus, S.. - (1992), pp. 1-14.

Availability:

This version is available at: 11696/34121 since: 2023-10-10T11:43:16Z

Publisher:

Published

DOI:

Terms of use:

This article is made available under terms and conditions as specified in the corresponding bibliographic description in the repository

Publisher copyright

(Article begins on next page)

**RAPPORTO TECNICO INTERNO
R 345**

The IMGC Hardness Standard Machine
Description of the actual software and
of proposed modifications

G. BARBATO, A. GERMAK, S. DESOGUS

Questo rapporto è stilato in lingua inglese in quanto è scritto per l'avvio del contratto tra IMGC e NIST per la costruzione di un nuovo durometro campione.

Torino, Gennaio 1992

THE IMGc HARDNESS STANDARD MACHINE

Description of the actual software and of proposed modifications

The IMGc Hardness Standard Machine, schematically represented in Fig. 1, is constituted by a weight carrier frame (E) which, descending, let a scale pan (S), and, in a given succession, the weights give the required forces on the indenter. The movement mechanism, at present constituted by an hydraulic jack, (J), is driven by two different software programs to realize Rockwell scales and Brinell and Vickers scales.

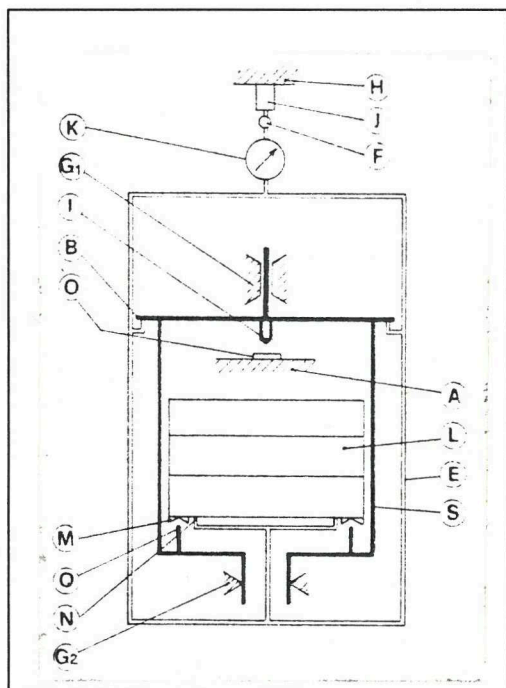

Fig.1 Sketch of main components of the machine at rest, showing indenter (I), scale-pan (S), guided by air bearing (G1) and (G2), and supported via pads (B) by outer carrier frame (E), hanging via elastic hinge (F) and load cell (K) from a hydraulic jack (J) on stationary cross-head (H). Stack of weights (L), carried at rest by the carrier frame (E) on pads (N), during indentation is transferred via cinematic mounts (M, Q) on the scale-pan (S) by lowering frame (E). Hardness block (O) is supported by stationary anvil (A).

ROCKWELL HARDNESS SCALES

Main Standard requirements

Testing procedure for rockwell hardness scales is described by the relevant standards. Here some main prescriptions are summarized:

- A) the initial descent velocity of the indenter, V_0 , (that is, the indenter velocity immediately before the contact of the indenter into the hardness block) must not exceed 1 mm/s
- B) the indenter is to be brought into contact with the surface of the hardness block and a preload F_0 is to be applied without shock and vibration

- C) the dwell time T_p of preload must be from 1 s and 10 s
- D) after the zero reference is taken with the indentation depth measuring-device, the load is increased from the preload F_0 to the total load F , without shock and vibration. The indenter velocity when the total load is reached must be between $5 \mu\text{m/s}$ and $20 \mu\text{m/s}$ or the time interval to go from preload to total load (T_l) must be between 2 s and 8 s
- E) the dwell time T_m of total load maintenance must range from 13 s and 15 s
- F) the additional load (F_1) is removed to return to preload level and the final reading of measuring device must be made immediately after load removal

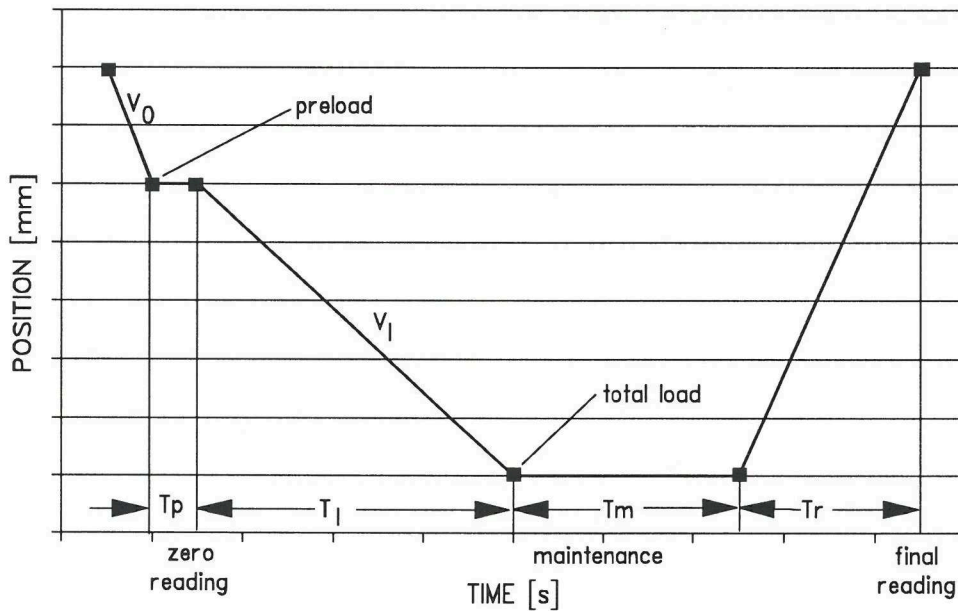
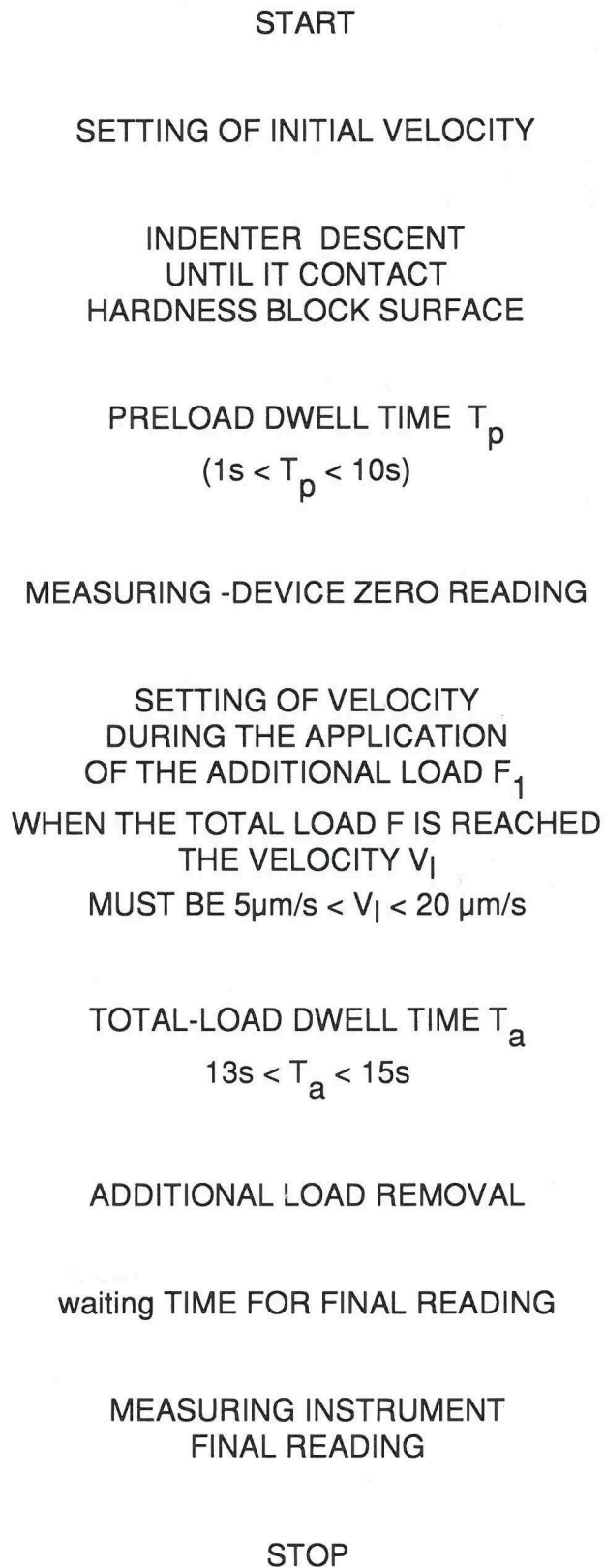

Fig. 2 Displacement vs. Time of the weight-carrier frame in the calibration of Rockwell hardness blocks, as requested by Standard specifications.

The testing procedure, schematized in Fig. 2, is illustrated by the following block diagram.



Present state of IMG C Machine

The tolerances given for the cinematic of the measuring cycle are responsible of about 50% of the uncertainty in Rockwell hardness measurement, and the tolerances given by the relevant standard are larger than the actual possibilities of the IMG C hardness standard machine. To have good reproducibility and stability it is necessary to work with more close tolerances:

$$T_p = 5s \pm 0.5s$$

$$T_m = 14s \pm 0.5s$$

For the dynamic of loading, the standard prescribe or a definite velocity in the moment the total load is applied to the indenter, or a given interval of time ($2s < T_l < 8s$) to go from the preload to the total load. With the IMG C Machine it is possible to change the velocity during the indentation, so that tests can be executed with the same velocity at total load and with different times interval from preload to total load, or with the same time interval and with different velocity. Extensive tests on different hardness blocks made at IMG C showed that the effect of speed changes are very significant (about 0.5 HRC at 65 HRC level for the tolerances accepted by the standard), while the variation of time interval at constant velocity is little or not significant. For this reason on the IMG C machine the speed during the indentation is very well controlled:

$$V_l = 9 \mu\text{m/s} \pm 1 \mu\text{m/s}$$

Fig. 3 shows the diagram of the operations and control of the IMG C hardness standard machine. The operation program for the hardness standard machine (Rockwell scales) is schematized in the following flow chart, at present implemented with an Apple II-plus personal computer in the AppleBasic language.

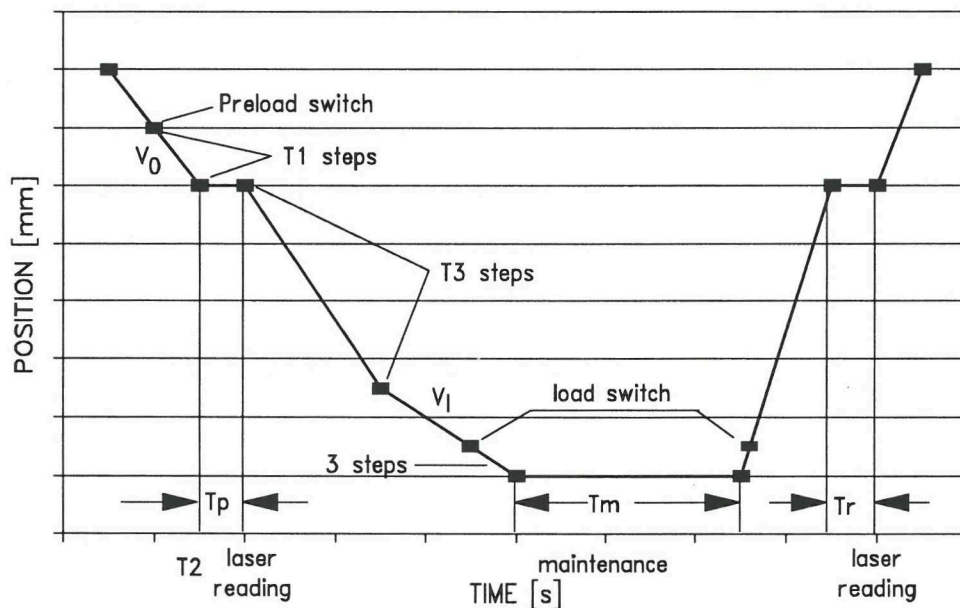

Fig. 3 Time vs. displacement in the present procedure for Rockwell-block calibration by the IMG C hardness standard machine.

START

SETTING OF INITIAL VELOCITY

INDENTER DESCENT
UNTIL IT CONTACTS
HARDNESS BLOCK SURFACE
(Some steps of descent after
Preload Switch S_p switches ON
to assure that preload is given)

PRELOAD DWELL TIME T_p
($4.5s < T_p < 5.5s$)

MEASURING -DEVICE ZERO READING
(reading R_0 on the laser interferometer)

SETTING OF THE INITIAL VELOCITY
DURING THE APPLICATION
OF THE ADDITIONAL LOAD F_1

AFTER A GIVEN TIME
SETTING OF THE FINAL VELOCITY
DURING THE APPLICATION
OF THE ADDITIONAL LOAD F_1
WHEN THE TOTAL LOAD IS REACHED
THE VELOCITY IS $V_1 = 9\mu\text{m/s} \pm 1\mu\text{m/s}$

WHEN THE TOTAL LOAD IS APPLIED
SWITCH S_c SWITCHES ON
(descent stops after some descent steps
to assure the application of the load)
TOTAL-LOAD DWELL TIME T_a
 $13.5s < T_a < 14.5s$

ADDITIONAL LOAD REMOVAL

WAITING TIME T_r FOR FINAL READING
($T_r = 1s$)

MEASURING INSTRUMENT
FINAL READING

STOP

New working procedure proposed

On the basis of the modifications specific of the standard hardness machine now under study and realization, it is envisaged to implement some variations to the previous scheme.

The hardware modifications consist in the use of a load-cell to have a continuous information of the load applied, and of a mechanical driving device with which a more prompt control can be obtained. With the new system it should be possible to have a continuous control of the speed during the indentation phase. Moreover, in parallel with the driving procedure, the outputs of the load cell and of the laser-interferometer have to be taken to allow the determination of the load-indentation curve; this part is not shown in the following schemes.

A procedure according to the following scheme is proposed:

The fundamental modification in respect of the procedure implemented (Fig. 4) and applied for the hardness standard machine in operation at the IMGCC (Fig. 1) is the addition of a real-time load control by a load cell. With the information thus provided it is possible to pilot the descent rate of the weight carrier as a function of the load being applied. The time vs. velocity graph in Fig. 6 schematizes the carrier velocity during the indentation.

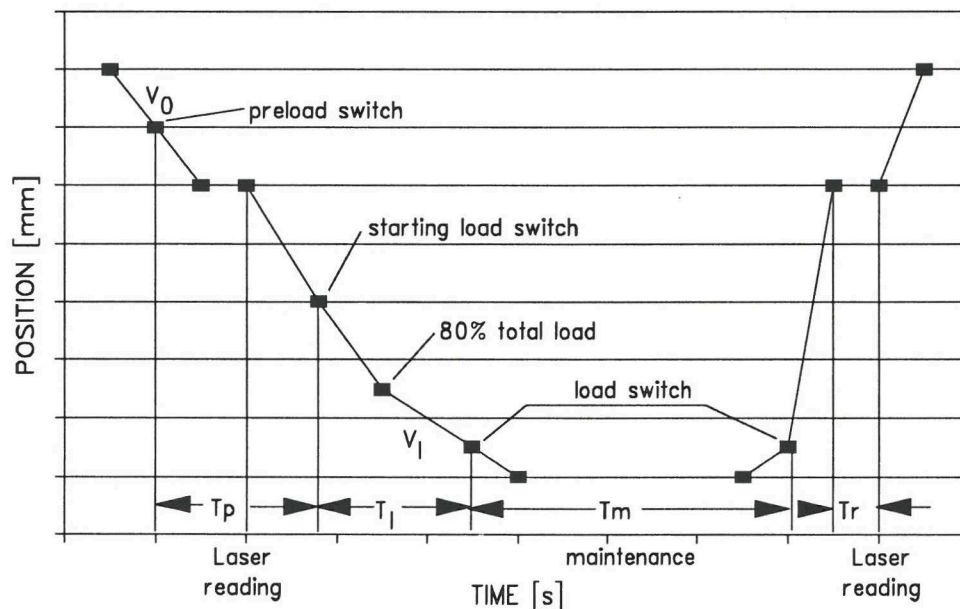

Fig. 4 Displacement vs. time in the procedure expected to be applied for the IMGCC-NIST hardness standard machine for the calibration of Rockwell hardness blocks.



START

SETTING OF INITIAL VELOCITY

INDENTER DESCENT
UNTIL IT CONTACTS
HARDNESS BLOCK SURFACE
(Preload Switch S_p switches ON)

The mechanical descent distance (about 2 mm)
to go from preload application
to the beginning of additional load
can be gone at constant deceleration
to start the additional loading with a given velocity

PRELOAD DWELL TIME T_p
($4.5s < T_p < 5.5s$)

MEASURING -DEVICE ZERO READING
(reading R_0 on the laser interferometer
is taken 4s after Preload Switch S_p switches ON)

THE VELOCITY DURING THE APPLICATION
OF THE ADDITIONAL LOAD F_1
IS VARIED CONTINUOUSLY
MANAGING TO ARRIVE AT 80% OF TOTAL LOAD
WITH THE VELOCITY OF $18\mu\text{m/s}$
WHICH SHALL BE KEPT CONSTANT $\pm 1\mu\text{m/s}$
UNTIL TOTAL LOAD IS REACHED

WHEN THE TOTAL LOAD IS APPLIED
SWITCH S_c SWITCHES ON
(descent stops after some descent steps
to assure the application of the load)
TOTAL-LOAD DWELL TIME T_a

$13.5s < T_a < 14.5s$

ADDITIONAL LOAD REMOVAL

WAITING TIME T_r FOR FINAL READING ($T_r = 1s$)

STOP



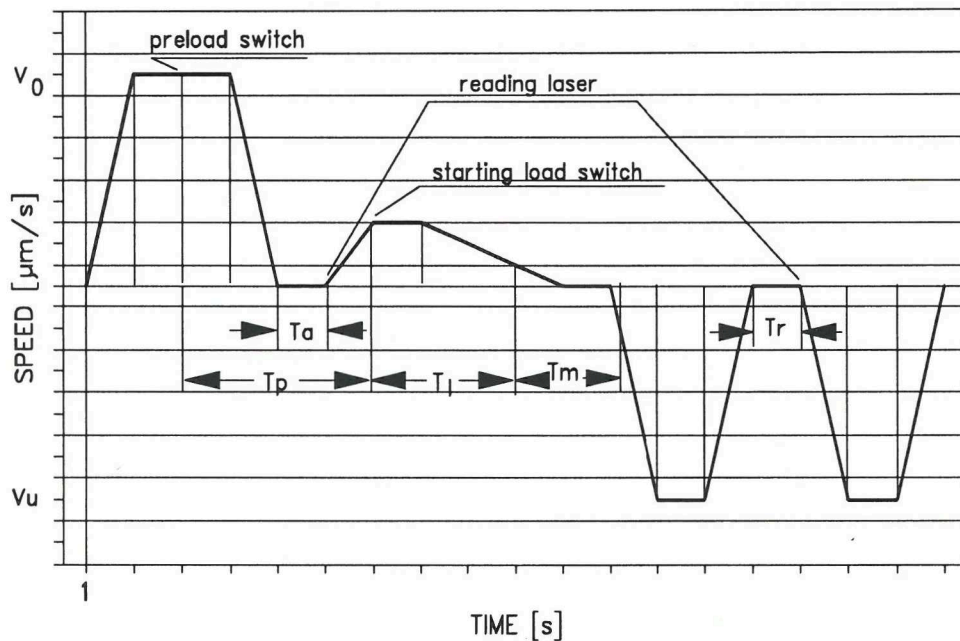

Fig. 5 Velocity vs. time in the procedure expected to be applied for the IMG-C-NIST hardness standard machine for the calibration of Rockwell hardness blocks.

The other modifications mainly concern the definition, as accurately as possible, of the different procedure phases; this allows velocity and duration to be better known and controlled. With such improvements it will be possible to change the quantities involved by means of variables susceptible of simple software control. It will thus be possible to study the way in which test results can be altered, even if within the limits established by specification, by variations in the velocity and time parameters and to define an ad-hoc procedure allowing the best possible reproducibility and stability be achieved.

Preloading

The time T_p prescribed by the Specification ranges between 1 s and 10 s.

For preload dwell time the time of $5s \pm 0.5s$ is chosen. It is then established that the laser reading is made after 4s. A time T_a could be necessary, during which motion is interrupted to allow the laser reading to be made with the motor switched off.

Loading

The Specification prescribes a velocity between $5\mu\text{m/s}$ and $20\mu\text{m/s}$; tests have shown that the higher variation of hardness vs. velocity attain at lower velocity, therefore it have been chosen a reference velocity of $18\mu\text{m/s}$ carefully controlled from 80% to 100% of the total load. In fact the results of tests carried out at NPL by R.S. Marriner, confirmed by measurements made at IMG-C, show that velocity must be checked during the final part of the loading process for conformity with the values prescribed by the specification.



To obtain shockless and vibrationless loading, a system should be studied, which, by the aid of the load cell and by starting from the highest velocity, controls it in such a way that when 80% of the total load is reached, the velocity is close to the reference velocity of 20 $\mu\text{m/s}$.

The weight carrier descent is meant to continue for some instants, to be sure that the weights are completely applied to the indenter.

Total Load dwell time

The specification indicates for load maintenance a time interval, T_m , from 13 s to 15 s. In the machine there is a Total Load Switch S_c which switches on when the total load is applied. The dwell time thus begins the moment the load switch turns on during the descent of the weight carrier and ends when the switch turns off during the rising of the weight carrier. The duration of motion interruption must be suitably regulated, so that the total time T_m have a values of $14\text{s} \pm 0.5\text{s}$.

The reproducibility of this interval depends on the position of the weights in reference to the weight-carrier. After the total load application the carrier descends some more, for a time T_d with the controlled reference velocity V_r , waits a given interruption time T_i and rise with the unloading velocity V_u ; but in the same time the weights position has crept down a distance D_c . One can take an indication of D_c reading the laser interferometer, but this could be non necessary as, if we accept a maximum value of $D_c = 100\mu\text{m}$ and an unloading velocity of $500\mu\text{m/s}$, the effect of D_c is a dwell time reduction of 0.2s

Laser reading

The laser reading is made after complete removal of the load. The specification prescribes the reading to be made immediately afterwards, thus leaving the operator somewhat free to choose the most suitable moment. On the basis of our experience, we establish a duration of 1 s for the time interval T_r elapsing between the moment the load cell signals that additional load is removed and the laser readings; as after this interval the machine conditions are stabilized, readings can be made.

Weight-carrier re-positioning

After laser readings the carrier continues its rising motion until it reaches the initial level; at this point the machine is ready for another calibration cycle



VICKERS AND BRINELL HARDNESS

The relevant standards for Vickers and Brinell hardness are, for the indentation phase, similar to the additional load application part of the Rockwell procedure. One has to note that, with reference to ISO standards, the Vickers procedure allows the use of a standard machine with a velocity control, but the Brinell procedure asks for a load rising time between 6s and 8s. It is clearly evident that the sensitivity of the material to the velocity of indentation is similar for the different shapes of indentation, and Marriner himself made some tests for the Vickers scale, so that in any case to get good reproducibility is necessary to have a reference speed when the total load is attained. The possibility of control of IMGC standard machine allows to fulfil the formal requirement of the time interval established by the standard and the physical requirement to have a reference speed, as the speed during the indentation can be controlled.

Present state of IMGC Machine

The procedure applied at present for the calibration of Vickers hardness blocks is schematized in the flow-chart given in the following, which is implemented at present on a personal Apple II-plus computer using the AppleBasic language.

According to the present procedure, an initial testing cycle is carried out before block calibration in order to have an approximate estimation of the height corresponding to the specimen surface. This makes it possible to approach the specimen surface at a considerable speed, to subsequently advance at low speed, until load is completely released.

The testing procedure implemented at present can be schematized as indicated in Fig. 6.

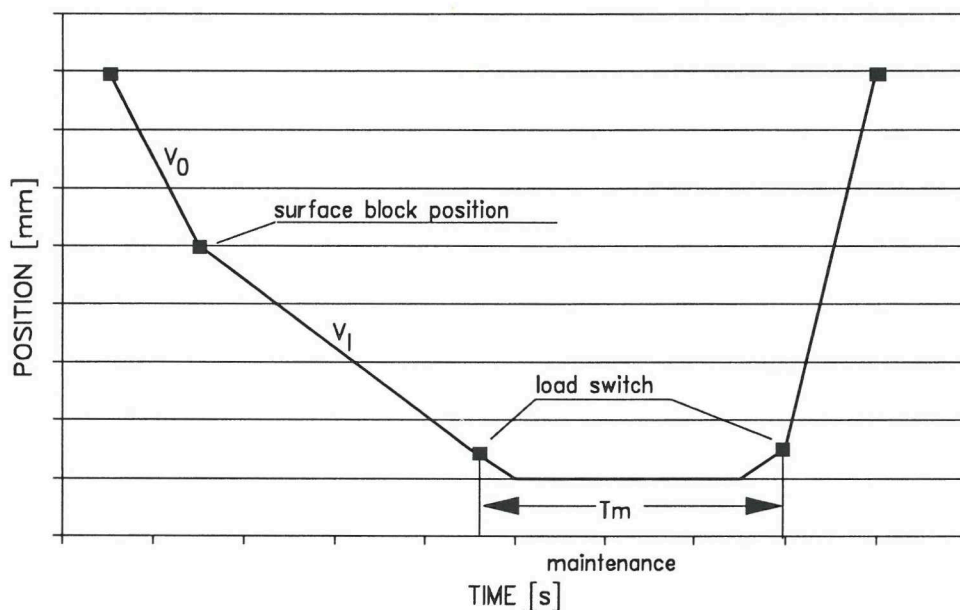
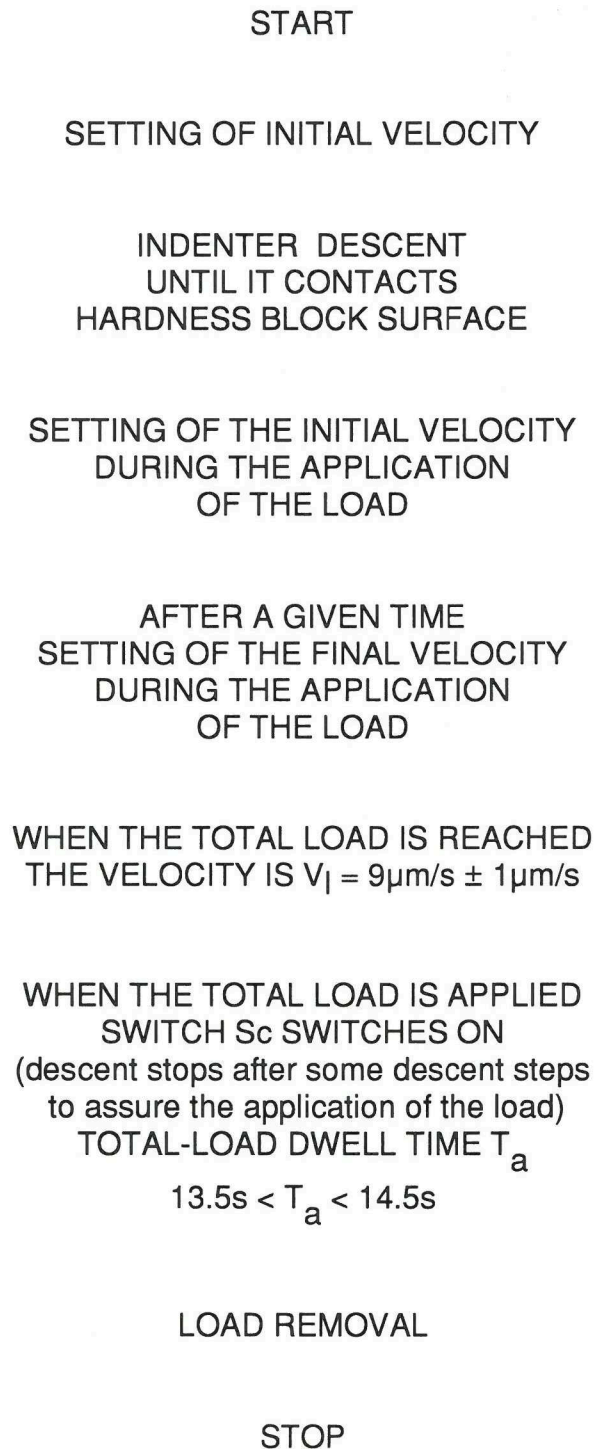

Fig. 6 Displacement vs. time in the procedure for Vickers-block calibration by the IMGC hardness standard machine.



By the testing procedure schematized in Fig. 6, the following block diagram is obtained



New working procedure proposed

On the basis of the modifications specific of the standard harness machine now under study and realization, it is envisaged to implement some variations to the previous scheme.



The scheme given in the following is proposed.

START

SETTING OF INITIAL VELOCITY

INDENTER DESCENT
UNTIL IT LOAD CELL SENSE
HARDNESS BLOCK SURFACE

SETTING OF THE INITIAL VELOCITY
DURING THE APPLICATION
OF THE LOAD

WHEN 80% OF THE LOAD
IS REACHED
SETTING OF THE FINAL VELOCITY
DURING THE APPLICATION
OF THE LOAD

WHEN THE TOTAL LOAD IS REACHED
THE VELOCITY IS $V_l = 9\mu\text{m/s} \pm 1\mu\text{m/s}$

WHEN THE TOTAL LOAD IS APPLIED
SWITCH S_c SWITCHES ON
(descent stops after some descent steps
to assure the application of the load)
TOTAL-LOAD DWELL TIME T_a

$$13.5\text{s} < T_a < 14.5\text{s}$$

LOAD REMOVAL

STOP

The essential advantage of the new procedure is that the initial testing cycle needs not to be made; in fact, it is no longer necessary to know the position of the specimen surface, since the load cell makes it possible to "sense" the moment loading begins and the descent rate of the weight carrier can be modified, so as to change from approach velocity to total load velocity.



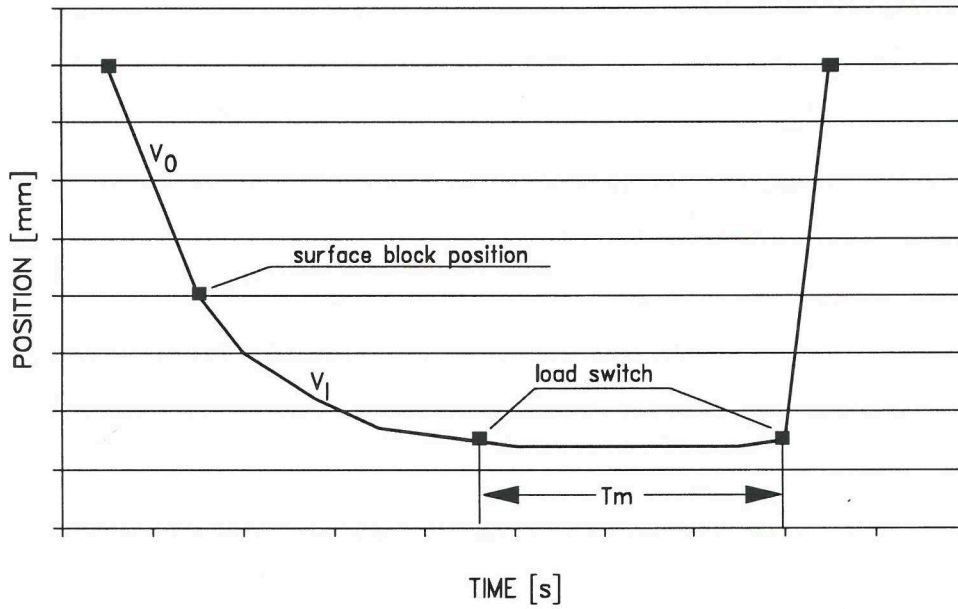

Fig. 7 Displacement vs time in the procedure proposed for Vickers-block calibration by the IMG-C-NIST hardness standard machine.

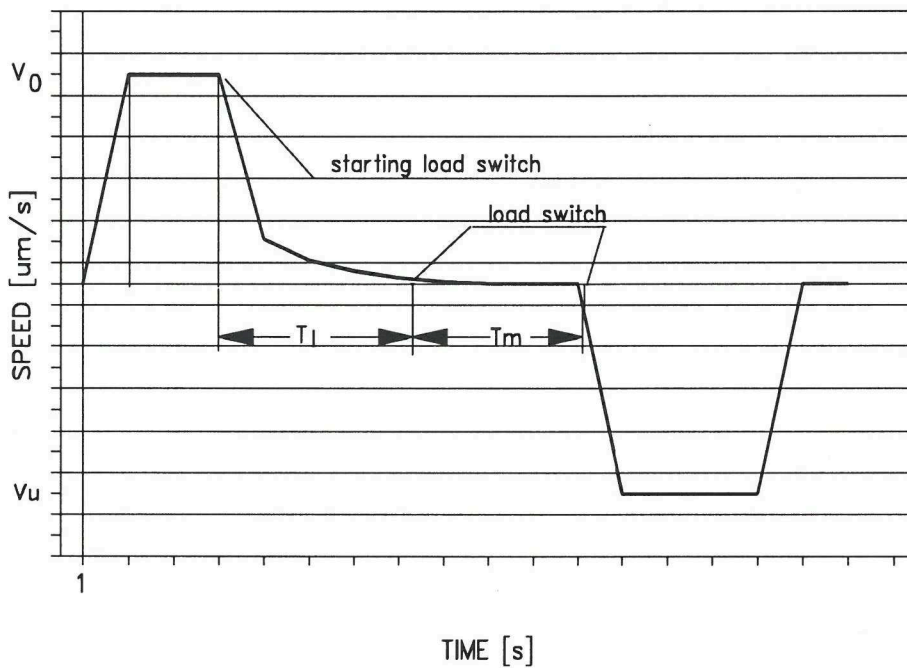

Fig. 8 Velocity vs. time in the procedure expected to be applied for the IMG-C-NIST hardness standard machine for the calibration of Vickers hardness blocks.



GENERAL CONSIDERATIONS

The study of new software programmes must be conducive to the implementation of procedures for the calibration of hardness blocks.

The main of the programme must contain a simple user interface, allowing one to choose the type of calibration to be carried out (normal Rockwell, surface Rockwell, Vickers, ...) or to read the data concerning previous calibrations. With this in view, it will be necessary to build up a data base with access from the main programme.

The subroutines required for programme development may be indicated, on the basis of a preliminary analysis, as follows:

- function defining Rockwell hardness types (normal, surface, etc.)
- definition of motor velocity
- motor control
- definition of laser interferometer parameters
- laser interferometer reading
- load-cell reading
- switch readings (preload, total load, start of additional load)
- dwelling times
- hardness calculation
- data storing
- definition of calibration procedure parameters (velocity, times)
- result printing
- access to data base
- calibration data definition
- calibration data display
- real-time parameter display during calibration.

